

## ABOUT THE COVER



Jared Dunten, MFPA, painter, writer and fundraiser

TIRR Memorial Hermann Patient, 2000

To view Jared's artwork and read his bio, please visit [jdunten.com](http://jdunten.com)

"I will paint myself out of this wheelchair."

Jared and his friends Marty Butler, Adam Butler and Craig Parker founded Will Walk ([willwalk.org](http://willwalk.org)), a foundation that works in conjunction with the Lone Star Paralysis Foundation and other organizations to raise funds for the first U.S. human clinical trial of adult stem cell therapy for spinal cord injury patients.

## ABOUT TIRR MEMORIAL HERMANN



A 134-bed not-for-profit rehabilitation hospital, TIRR Memorial Hermann has been named one of “*America’s Best Hospitals*” by USNews & World Report each year since the survey began in 1990. TIRR Memorial Hermann provides rehabilitation services for adults and adolescents with spinal cord injuries, brain injuries, stroke, amputations, neuromuscular disorders and multiple trauma.

In May 2006, TIRR Memorial Hermann joined the Memorial Hermann Healthcare System, a not-for-profit community-owned healthcare system dedicated to providing high-quality services to improve the health of southeast Texans.

*This manual is dedicated to the patients and caregivers who inspire us every day.*

## WELCOME TO TIRR MEMORIAL HERMANN

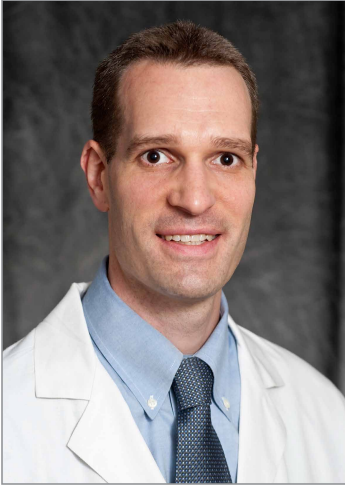

We would like to welcome you to TIRR Memorial Hermann, a rehabilitation hospital with a long history of service to people with spinal cord injuries. Our patient care environment blends passionate people, exemplary care by some of the world's leading physicians, and a genuine commitment to your overall quality of life. You will also find strong support that will help you return to productivity as a valued member of the community.

This manual was written for you, your family and your friends to explain the philosophy behind our Spinal Cord Injury Program and the continuum of care we provide for people with spinal cord injuries – from your first few days with us until your discharge from inpatient care. Education is a major component of our program. Readiness and Preparation for Self-Care (RAPS) classes are held every day, and each session covers a topic important to healthy living with a spinal cord injury. We welcome and encourage the participation of your family and friends in your rehabilitation program.

We began our Spinal Cord Injury Program more than 50 years ago in 1960, and through the years have gained national and international recognition for our expertise. As we work with you to overcome obstacles and learn new skills, we remember the words of rehabilitation pioneer Howard Rusk: Medicine adds years to life, and rehabilitation adds life to years. We look forward to working with you to achieve your rehabilitation goals and a successful reintegration into the community.

Please let us know how we can help you and your family during your stay with us.

With warm regards,

*MATTHEW DAVIS, M.D.  
Clinical Director, Spinal Cord Injury Program  
TIRR Memorial Hermann*

*Clinical Professor of Physical Medicine and Rehabilitation  
McGovern Medical School at UTHealth*

## TABLE OF CONTENTS

Chapter	Subject	Page
1	History and Mission of TIRR Memorial Hermann .....	1-2
2	Spinal Cord Injury (SCI) Program Philosophy and Continuum of Care.....	3-4
3	Introduction to the SCI Program.....	5-9
4	Overview of Spinal Cord Injury .....	10-14
5	Autonomic Dysreflexia, Circulation and Cardiovascular Issues Following Spinal Cord Injury.....	15-19
6	Skin Management .....	20-26
7	Bladder Management.....	27-34
8	Bowel Management.....	35-42
9	Breathing after Spinal Cord Injury .....	43-50
10	Nutrition .....	51-53
11	Exercise, Range of Motion, Spasticity and Posture .....	54-60
12	Mobility and Equipment.....	61-69
13	Psychosocial Functioning.....	70-74
14	Sexuality .....	75-82
15	Independent Living.....	83-87
	- Attendant Care .....	83-84
	- Transportation and Driving.....	85-87
	- Recreation and Leisure .....	87
16	Your Rights and the Americans with Disabilities Act (ADA) ...	88-91
17	After You Leave TIRR Memorial Hermann.....	92-94
18	Continuing Care and Financial Resources .....	95-98
19	A Word About the Future.....	99
20	Resources .....	100-112





William A. Spencer, M.D.  
Founder

*“The purpose of rehabilitation is to protect the individuality of the person facing disability and to provide opportunities to pursue goals, expectations and dreams that are important to that individual. That’s what makes you a person. Having some control over your existence is a basic human right. My vision was guided by how much people could do in spite of tremendous losses.*

*In reflecting on what rehabilitation should be today, I don’t think the key areas are any different. Individualization of care is fundamental to protect the individuality of the person and provide opportunities for a productive and rewarding life. The resources are different today, including personnel, technology and financing, but the need remains fundamental: to find the means to reach ends that matter. My vision is symbolized by Prometheus, who is reaching upward in spite of being chained – rehabilitation is about finding resources and ways to reach valued goals in spite of difficulties and constraints.”*



TIRR (The Institute for Rehabilitation and Research) was founded by William A. Spencer, M.D., in 1959. Previously known as the Southwestern Poliomyelitis Respiratory Center in Houston, it was one of the first polio treatment centers in the United States. Dr. Spencer’s efforts in treating polio survivors led to the donation of funds for a not-for-profit hospital in the Texas Medical Center. Originally named Texas Institute for Rehabilitation and Research, the hospital later became The Institute for Rehabilitation and Research.

The knowledge and skills that Dr. Spencer gained while treating polio survivors became the foundation for treatment of patients with a broad range of disabilities caused by illness and injury. Dr. Spencer believed in helping people become as independent as possible and achieve the best possible quality of life. His commitment to treatment, research, education and the community continues to be the guiding force at TIRR Memorial Hermann and can be seen daily in the work of the Spinal Cord Injury Program.

TIRR Memorial Hermann has been serving patients with spinal cord injuries (SCI) since 1960. Physicians and clinicians affiliated with TIRR Memorial Hermann have a long history of national and international recognition for their expertise in SCI medicine.

In addition to patient care, TIRR Memorial Hermann provides educational opportunities for many healthcare professions. We are affiliated with two medical schools, The University of Texas Health Science Center at Houston (UTHealth) Medical School and Baylor College of Medicine. We also work with many universities across the country to provide clinical training and supervision for students of nursing, pharmacy, physical therapy, occupational therapy, speech-language pathology, neuropsychology, optometry, music therapy, therapeutic recreation, social work, health information management and other disciplines. Research is also part of TIRR Memorial Hermann’s

mission, and many physicians and other staff members participate in major research projects and grants.

**TIRR MEMORIAL HERMANN MILESTONES**

TIRR Memorial Hermann provides comprehensive rehabilitation services to individuals with SCI and conducts research to foster advances in SCI rehabilitation.

**SCI Model System Dissemination Center:**

TIRR Memorial Hermann was awarded the first grant as the SCI Model System Dissemination Center for all 14 SCI Model Systems nationwide.

**Pioneering Treatment:** TIRR Memorial Hermann was the first SCI Model System in the United States to implant baclofen pumps and phrenic nerve stimulators.

**Rehabilitation Research and Training Center**

**(RRTC) Grants:** TIRR Memorial Hermann received RRTC grants for the entire period in which these grants were awarded by NIDRR (1962 to 2000). These grants fostered education and training related to SCI issues and to reintegration of people with SCI into the community.

**NeuroRecovery Network:** In 2006, TIRR Memorial Hermann received a grant from the Christopher and Dana Reeve Foundation to partner with three other national centers in developing locomotor training services for people with SCI.

**Mission Connect:** Initiated in 1997 by TIRR Foundation, Mission Connect is a collaborative research effort with the goal of improving the function of patients with spinal cord and brain injuries by affecting the biology of the nervous system. The collaborating partners include TIRR Memorial Hermann, The University of Texas Medical Branch at Galveston, The University of Texas Health Science Center at Houston (UTHealth) Medical

School, Baylor College of Medicine and Texas A&M University Systems Health Science Center/Institute of Biosciences and Technology.

**Leadership in American Spinal Injury Association (ASIA):**



**R. Edward Carter, M.D.,** medical director of the SCI Program at TIRR Memorial Hermann from 1961 to 1997, was a founder of the American Spinal Injury Association (ASIA). He served as the first president from 1973 to 1977.



**William H. Donovan, M.D.,** was president of ASIA from 1987 through 1989 and president of the International Spinal Cord Society (ISCoS), serving a term from 2004 to 2008.



**Kenneth C. Parsons, M.D.,** medical director of the SCI Program at TIRR Memorial Hermann from 1997 until 2006, was president of ASIA from 1997 to 1999.



**SCI PROGRAM PHILOSOPHY**

The rehabilitation team of TIRR Memorial Hermann's SCI Program developed the following philosophy of care:

The Spinal Cord Injury Program sets the standard of excellence in the international rehabilitation community for the rehabilitation of persons with spinal cord injuries.

The Spinal Cord Injury Program at TIRR Memorial Hermann is a role model for quality patient care throughout the continuum of services.

We focus on patient needs and practice a unified, interdisciplinary approach to patient care.

We work efficiently and in collaboration with all members of the healthcare team internal and external to our program.

We are recognized for our excellence in the responsible management of patients' lifetime resources.

We are current in our knowledge and innovative in our treatment practices and use of technology.

We are internationally recognized for our research, education and research/clinical interface with interdisciplinary focus.

We are advocates on a local, state and national level for persons with spinal cord injuries, individually and as a group.

**Purposes of Rehabilitation**

- To help people learn to function as independently as possible
- To lessen any medical complications caused by the injury or illness
- To provide education about spinal cord injury to our patients and their families
- To provide information about community resources to our patients and their families
- To train family members and other caregivers to provide appropriate care
- To provide appropriate referrals for care following discharge

## THE CONTINUUM OF CARE

### Inpatient Programs

The inpatient SCI program has several categories, each of which has distinctive goals.

#### Rehab I Program

If you have been admitted to TIRR Memorial Hermann with a new spinal cord injury, you are probably in the Rehab I program. This admission category focuses on treating and/or preventing medical complications; establishing bladder, bowel and skin routines; improving strength, endurance and function; and providing intensive patient and family education about spinal cord injury.

#### Rehab II Program

The Rehab II program focuses on advanced functional training, including independence with bathing and bowel and bladder care.

The rehabilitation team often recommends phased admissions. Phased admissions mean, for example, that a patient may be in Rehab I for a few weeks, then go home before readmission for Rehab II. During the time between admissions, the patient may continue to work on building strength and endurance while waiting for a body jacket or neck brace to be removed. Once readmitted to Rehab II, the patient will be able to participate in more advanced activities.

### Outpatient Programs

When you no longer need inpatient rehabilitation, you may continue to work toward your goals in an outpatient setting. TIRR Memorial Hermann outpatient programs include:

TIRR Memorial Hermann Outpatient Rehabilitation at Kirby Glen provides Outpatient Rehabilitation and Day Rehabilitation services to adult, adolescent and pediatric patients who no longer require 24-hour nursing care. Day Rehabilitation includes the Challenge Program, specialized services for persons recovering from brain injury or stroke.

TIRR Memorial Hermann Outpatient Medical Clinic is a physician-based clinic designed to meet the various needs of individuals who require initial or continuing rehabilitation care with a physician.

### Other Healthcare Providers

When appropriate, you will be referred to other healthcare providers, such as skilled nursing facilities, home health agencies, nursing homes or other therapy providers.

### **YOUR FIRST FEW DAYS AT TIRR MEMORIAL HERMANN**

Your experience at TIRR Memorial Hermann will be very different from an experience you would have at most other hospitals. During the first few days you'll meet your team members. They will complete evaluations, work with you to set goals, get you up in a wheelchair and start treatment. It will take a few days to fully establish your rehabilitation program.

As your endurance and stamina improve, you'll be busy throughout the day. After your therapists and nurses teach you new techniques, you'll be able to perform or instruct much of your own care. Your family members or caregivers will also be expected to learn and participate in your care regimen so that they will be fully prepared when you leave TIRR Memorial Hermann to go home.

You'll also begin routine daily activities, many of which you'll continue throughout your rehab stay. For example, nursing staff will begin to turn you in bed on a regular schedule (every two hours at first), and they'll perform regular checks of your skin. See Chapter 6 for additional information on skin management.

You'll also begin bladder and bowel programs. You may participate in intermittent catheterization (also known as ICP or cathing), a procedure to empty your bladder of urine. Your physician will determine the schedule – usually every four to six hours. See Chapter 7 for more information on bladder management.

Your bowel program will usually be scheduled every evening or morning, as determined by your physician or nurse. It should occur at approximately the same time each day, so that it will be regulated by the time you go home. Please ask your visitors to visit early so that you can complete the bowel program early and be ready to sleep. See Chapter 8 for more information about bowel management.

### **AFTER THE FIRST FEW DAYS**

Activities at TIRR Memorial Hermann begin as early as 7:30 a.m. The nursing staff may wake you as early as 6 a.m. to prepare for your first therapy session. If your doctor has ordered a blood test, the nurses will draw your blood early in the morning. Because of early morning activity, you'll want to get to sleep on a regular schedule.

We will post a schedule for each day in your room. You'll be responsible for knowing what you should be doing and where you should be throughout the day. While the schedule stays the same from day to day, as much as possible, please check your schedule each morning in case changes do occur. Our team members will let you know of any changes.

Therapy is provided on Saturdays as needed. Therapy is provided on all holidays except Thanksgiving and Christmas.

### **YOUR TREATMENT TEAM**

Your team will work with you and your family to establish goals, provide treatment and education, and prepare you for your discharge from TIRR Memorial Hermann. Your core team members are:

**Physiatrist** A physician specializing in physical medicine and rehabilitation who is responsible for your overall medical care and treatment; refers you to consultants as appropriate.

**Licensed Nurse (RN or LVN/LPN)** Provides rehabilitative nursing functions; trains you and your family members or caregivers to provide your nursing care at home.

**Occupational Therapist** Teaches the skills to provide for your self-care needs, such as feeding, grooming, hygiene and dressing; evaluates and recommends the appropriate equipment, such as wheelchair, cushion and adaptive devices.

**Physical Therapist** Teaches the skills you need to increase your mobility, such as turning in bed and transfers to different level surfaces; evaluates and recommends the appropriate equipment, including hospital bed, slide board and bathroom equipment.

**Social Worker** Initiates community resource referrals; provides counseling to you and your family to deal with the stress of your spinal cord injury and plan for the future.

**Case Manager** Coordinates your overall program; communicates the status of your goals and the team's recommendations to your funding source; plans for discharge needs.

Other TIRR Memorial Hermann staff who may be involved with your care include:

- Rehab tech or patient care assistant
- Respiratory care practitioner
- Dietitian
- Speech-language pathologist
- Therapeutic recreation specialist
- Neuropsychologist/Psychologist
- Chaplain
- Psychiatrist
- Medical consultants

## THERAPY

You'll have therapy individually and also in group sessions. Your program will be designed specifically to meet your goals and needs. Please check with your therapists if you have questions.

Your therapists may also suggest that you participate in a therapeutic community outing. You will work with other patients to plan the outing and then leave the hospital for a few hours to enjoy and learn from the experience.

## WHEELCHAIR TRIALS

Your therapists will get you up in a wheelchair when your doctor has written the order to do so. TIRR Memorial Hermann maintains a pool of different wheelchairs and wheelchair equipment, some of which is provided to TIRR Memorial Hermann by vendors or manufacturers. We ask that you take care of this equipment. If you have any questions, please check with your therapist.

When you're admitted, you'll be assigned a wheelchair from the hospital pool (power and/or manual) and special accessories, including a pressure-reducing seat cushion. If you order a wheelchair for use at home, your therapists will guide you in trying different wheelchairs to see which is the most appropriate for you. You may use each of these chairs for a few days.

Even if a particular wheelchair seems to suit you, you may not be able to use it indefinitely because other patients may also need to try it. We'll make every effort to ensure that you have a wheelchair that fits and is easy to use. Identifying the most appropriate wheelchair for your needs may take a few weeks.

## TEAM ROUNDS

Your team will meet weekly to review your goals and progress, to make plans for your discharge and to give you an opportunity to ask questions. Your physician will update you on the findings and occasionally you may be invited to attend team rounds.







Team rounds are scheduled for a 15-minute time period. We make every effort to stay on schedule. Your social worker will explain the rounds process more fully and prepare you for using this valuable time with your team efficiently.

### **MEDICAL STATUS CONFERENCE**

A medical status conference is routinely scheduled in the first phase of your rehabilitation. The conference is designed to allow you and your family to meet with your physician to discuss your medical status. You'll also have an opportunity to review X-rays and ask questions about your spinal cord injury.

### **RAPS**

#### **(READINESS AND PREPARATION FOR SELF-CARE)**

Education about spinal cord injury is a major component of the SCI Program. Sessions occur in a group setting and are taught by nurses, therapists, pharmacists, dietitians, social workers, former patients and others, and will be scheduled for you and your caregivers by team members.

RAPS classes are held every day. There are various classes, each covering a specific topic important to healthy living with a spinal cord injury. The master calendar of RAPS classes is located at the nurses' station. Your team will schedule you for the appropriate classes. Family members and caregivers are also invited and encouraged to attend these classes.

### **SCI EDUCATION MANUAL**

We encourage you and your family to bring this manual to the RAPS classes, which will help you understand the information presented. Team members will also refer to the manual as they provide individual instruction. Families have told us that they have referred back to their manual many times after returning home.

### **YOUR FAMILY AND FAMILY TRAINING**

Family involvement and understanding of the care you'll need is important for a successful rehabilitation experience. At TIRR Memorial Hermann, we welcome and encourage your family's participation in your rehabilitation program.

You and your family or caregivers must complete individual training sessions and be cleared by your therapists and nurse before you leave the hospital on a pass or at discharge. It is your responsibility to coordinate the specific training times with appropriate team members.

### **PASSES**

Before discharge, your rehabilitation team may recommend a therapeutic day and/or overnight pass. The pass will give you the opportunity to return to your home setting (if practical) and identify specific areas of concern, such as steps and narrow doorways, that can be addressed with your team members. Passes are also helpful as you begin the emotional process of returning to your community. You may experience physical problems during your time away from the hospital that you need to discuss with your therapist or nurse, or emotional or social difficulties that you'll want to discuss with your social worker.

Your therapist may arrange to loan you certain equipment for trial during a therapeutic day pass. Equipment we loan includes, but is not limited to: manual wheelchairs, sliding boards, lifts and bathroom equipment.

Funding sources will sometimes have limitations on coverage for passes. Be sure to discuss these limitations with your case manager.

You may have one overnight pass and two day passes, as recommended by the team and approved by your health insurance plan.

While you're away from TIRR Memorial Hermann on a pass, we'll ask you to complete a Therapeutic Pass Assessment form, which provides valuable information to the team about your additional training needs or needed home modifications.

### **DISCHARGE PLANNING**

"If we fail to plan, we plan to fail." Planning for discharge means planning where you will live when you leave TIRR Memorial Hermann and who will provide your care.

We'll begin discussing your discharge the day you're admitted, possibly even before admission. Every team member plays a role in preparing you and your family for discharge. We discuss goals for discharge each week in team rounds, and a tentative discharge date will be given to you as soon as the first week. Your discharge date is based on achieving goals that must be met in the inpatient hospital setting. Many goals can be continued in the home or outpatient settings.

If you or your family members have concerns about your preparation for discharge, please let your team members know. Although the idea of leaving the hospital can be frightening, we want to do all we can to make the transition to home as easy as possible for you and your family.

Your recovery and rehabilitation will not stop at discharge. The rehabilitation process continues whether you're in the hospital or at home. You and your therapists will begin discussion about continued rehabilitation options such as outpatient rehabilitation, home health, home exercise programs, Strength Unlimited, etc.

After discharge you'll have a follow-up appointment with your physiatrist in TIRR Memorial Hermann's Outpatient Medical Clinic.

### **TIRR PEERS**

The TIRR PEERS program links new patients with former patients to share experiences, support and ideas. If you're interested in participating, the organizers will do their best to match you to your TIRR PEER based upon age, sex, level of injury and interests. You and your TIRR PEER work together to determine the frequency of contact.

### **HANG TIME FOR ADOLESCENTS (12-17 YEARS OF AGE)**

If you are between the ages of 12 and 17, you may be invited to participate in Hang Time, a specialized group that meets in addition to your regular therapy. The group includes teenagers with different types of disabilities (spinal cord injury, brain injury, multiple sclerosis, etc.) and addresses the specialized needs of adolescents. Hang Time enables adolescents to develop a support system of peers who are going through similar life situations physically, emotionally and psychologically.

### **SCHOOL SERVICES**

Children and adolescents may be eligible for school services. You can enroll in school if you will be at TIRR Memorial Hermann for at least four weeks and if you are physically able to participate in school. The school room is staffed by teachers from the Houston Independent School District (HISD).

The rehabilitation team determines whether children and teens may participate in school activities and refers them for school services. An hour is scheduled for class each day. The teachers may also participate in team rounds.

The teachers incorporate schoolwork from your home school and will also assist in the process of returning you to your home school district. Ask your social worker about public regulations that provide for the

education of children with disabilities up to the age of 22.

### **BLADDER EVALUATION**

Most SCI patients will be seen by an urologist for a bladder evaluation. The urologist may order a renal ultrasound and/or VUDS (video urodynamics study). Your urologist will discuss any recommended procedures with you, as well as available medications or techniques to help you manage your bladder.

### **PATIENT SAFETY**

TIRR Memorial Hermann makes every effort to keep our patients, families and visitors safe. We encourage you to assist us by becoming involved in your care and letting us know how we can make the environment safer.

### **INFECTION CONTROL**

We take numerous steps to minimize the spread of germs. However, it is impossible to completely eliminate them.

Organisms can be found on the skin and in saliva, urine, feces, blood and wounds. Some organisms are highly contagious and do not respond well to medication. That's why it's important to take preventive measures.

**HAND WASHING** is the single most important means of preventing the spread of infection. **A minimum of 15 seconds** is necessary to effectively remove germs from your hands.

- Wet hands with water, keeping hands lower than your elbows.
- Apply a hospital-approved soap or antiseptic. Liquid soap dispensers are available at every sink.
- Use friction to clean between fingers, palms, back of hands, wrists, forearms, under nails and around jewelry.
- Rinse your hands under warm water.
- Use a paper towel to dry your hands and use the towel to turn off the faucet.

Staff members wash their hands between patient contacts and often change gloves in the middle of a procedure. They may also use the hand sanitizer (waterless hand agent) found in the dispensers outside each patient room. We encourage patients and families to ask staff members if they have washed their hands.

Patients and families can help prevent the spread of germs by washing their hands often or using the hand sanitizer and encouraging visitors to do the same, especially before leaving the patient room or after providing any type of care. Please check with the nursing staff to learn how to properly dispose of soiled items and linen.

Some organisms require the patient to be placed on isolation. If you are on isolation there will be a sticker on your door designating the type of isolation. There will also be a cart outside the room containing gowns, gloves, masks and other required equipment. Few patients require these safeguards, and they do not usually require private rooms. In fact, two patients with the same organism often share a room.

Infection control consultants are available to our staff and determine what measures need to be taken. If you have any questions about the prevention of the spread of infections, please ask the nursing staff.

### **PATIENT IDENTIFIERS**

Patient safety guidelines require that staff utilize "double identifiers" before administering medications or procedures. This means that a staff member will check your wristband to verify your name and patient number before giving you your medications or performing any procedure. This practice has helped to reduce errors.

**HIGHLIGHTS**

- The **spinal cord** is the “communicating link” between the brain and the rest of the body.
- What is commonly known as the “spine” actually consists of two structures: the spinal or vertebral column and the spinal cord. The spinal cord is a long bundle of nerve fibers that runs through the center of the spinal column from the base of the brain to the small of your back.
- Injury can occur to the spinal column (vertebrae) and/or to the spinal cord.
- The severity of a spinal cord injury is determined by the spinal cord level(s) at which the damage occurred and the amount of nerve damage at that level.
- Tetraplegia (quadriplegia) results from an injury in the neck and can affect breathing, bowel and bladder functioning and feeling and movement of the arms, legs and trunk.
- Paraplegia results from an injury below the neck and can affect breathing, bowel and bladder functioning and feeling and movement in the trunk and legs.
- Complete injury means that there may be no ability to move or feel touch, pain or pressure below the level of the injury.
- Incomplete injury means there may be some ability to move or to feel below the level of injury.

**OVERVIEW OF THE SPINAL CORD**

The central nervous system (CNS), which is made up of the brain and the spinal cord, is the “control center” of your body. It sends out all the signals to control movement and most of the other body functions. The CNS also receives and interprets information about

sensations of touch, pain, sights and sounds that allows you to react to the environment.

The spinal cord is the “communicating link” between the brain and the peripheral nerves. Peripheral nerves – the “workforce” of the nervous system – connect the spinal cord with all the areas of your body. They send and receive messages that provide movement and sensation.

**THE SPINAL CORD AND SPINAL COLUMN**

What is commonly known as the “spine” actually consists of two structures: the spinal or vertebral column and the spinal cord. The spinal column is made up of 33 stacked bones called the vertebrae. It has five sections (see Figure 4:1):

- 1.- Cervical area - 7 bones – C 1-7 (neck)
- 2.- Thoracic area - 12 bones – T 1-12 (chest)
- 3.- Lumbar area - 5 bones – L 1-5 (lower back)
- 4.- Sacral area - 5 bones fused together – S 1-5 (sacrum or area below waist at the top of the buttocks)
- 5.- Coccyx area - 4 bones (tailbone)

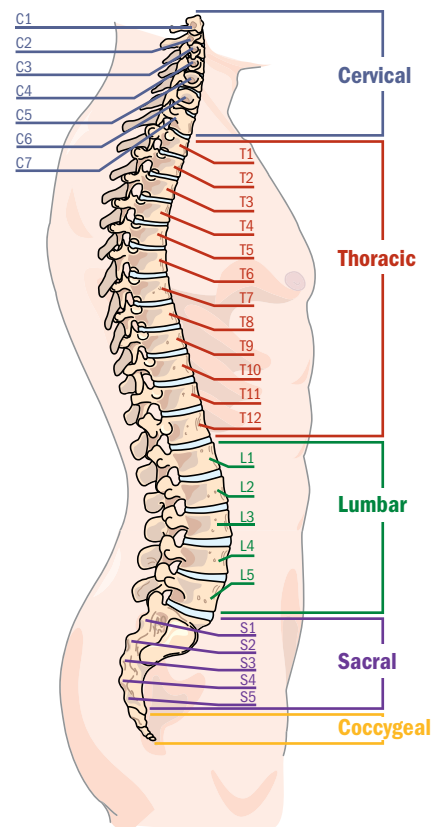

Figure 4:1 Side view of spinal column.

Each vertebra has a spinous process (the bony bumps you feel in the center of your back), two transverse processes (bony protrusions to the side), a vertebral body and a spinal canal where the spinal cord runs through these bones.

Each vertebra is separated from the one next to it by a disc. The discs can be thought of as “shock absorbers” that reduce pressure between vertebrae. The vertebrae are held together by ligaments that go up and down the entire backbone. These ligaments allow the neck and back to turn and bend and be flexible. The main function of the vertebrae is to protect the spinal cord from being injured and to allow some flexibility but not extremes of movement in the spine.

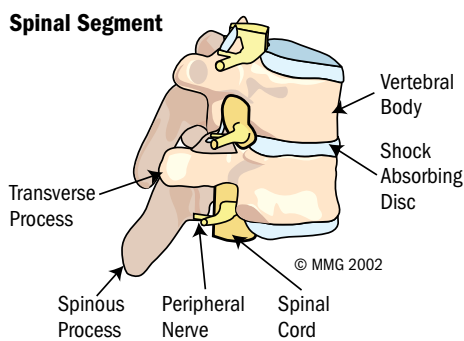

Figure 4.2 Side view of two vertebrae.

The spinal cord is a long bundle of nerve fibers (about as thick as your little finger) that runs through the center of the spinal column from the base of the brain to the small of your back (see Figure 4.3). At the end of the spinal cord is a group of nerve roots that together form the cauda equina. Cauda equina in Latin means “horse’s tail” and describes the appearance of this part of the spinal cord. Branching from the spinal cord are 31 pairs of spinal nerves: eight cervical nerves that control breathing and functions in the neck and arms, 12 thoracic nerves that control trunk functions, five lumbar nerves that control the front part of the leg, five sacral nerves that control the back part of the leg, bowel, bladder and sexual function (primarily in males) and one coccygeal nerve.

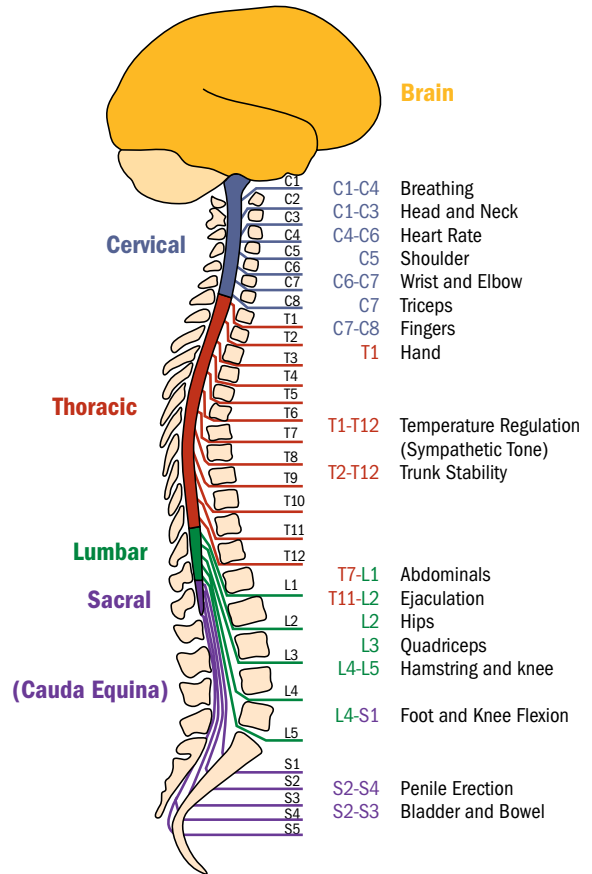

Figure 4.3 Side view of brain and spinal column.

The spinal nerves and the nerve fibers in the spinal cord work like two-way telephone lines, carrying messages back and forth between the brain and the body.

**There are two types of nerve pathways:**

Sensory nerves receive sensations of touch, pain, temperature, etc., from the skin, muscles and joints and relay this information to the brain. With this information, the brain is able to interpret what we taste, touch, hear, see and feel.

Motor nerves receive instructions for movement from the brain and take them to specific muscles in the arms, trunk and legs.



**INJURY OF THE SPINAL CORD**

Injury can occur to the spinal column (vertebrae) and/or to the spinal cord. A bony injury, such as a fractured vertebra, can occur without causing injury to the nerves in the spinal cord. It heals the same way a fracture heals in any other part of the body.

Sometimes an injury can occur to the spinal cord without a fracture to the vertebra. When an injury affects both the vertebra and the spinal cord, your doctor may refer to two levels of injury: the level of the fracture (“bony level of injury”) and the level at which your nerve function is affected (“neurological level of injury”).

Injury to the spinal cord interrupts the messages flowing back and forth between the brain and body. The initial phase after a spinal cord injury is called spinal shock or swelling. Nerve cells (neurons) in the spinal cord are typically damaged by swelling that results after the injury. Swelling causes a decrease in blood flow and delivery of oxygen to the tissues; this leads to increased waste products and consequently to neuron damage and death of the nerve.

As the swelling or spinal shock decreases, the damaged nerves may begin to send messages again. Only time will tell which damaged nerves may begin to conduct messages. Rarely is the spinal cord severed (cut in half) unless injury is inflicted by a weapon or bullet fragment.

The severity of the injury is determined by the spinal cord level(s) at which the damage occurs and the amount of nerve damage at that level. The higher the level of injury to the spinal cord, the greater the loss of function (movement and sensation). The section of the spinal cord above the level of injury will continue to work but the messages below the level of injury will be impaired.

The level of injury is described in one of two ways: tetraplegia and paraplegia.

Tetraplegia (quadriplegia) results from an injury in the neck (cervical area) and can affect breathing, bowel and bladder functioning and feeling and movement of the arms, legs and trunk.

Paraplegia results from an injury below the neck (thoracic or lumbar area) and can affect breathing, bowel and bladder functioning and feeling and movement in the trunk and legs (but not arms and hands).

The larger or more involved the injury is to the spinal cord, the fewer the messages that will be allowed to pass around the site of injury. Injury to the spinal cord may be complete or incomplete.

Complete injury means that there may be no ability to move or feel touch, pain or pressure below the level of the injury. A complete injury is classified by the American Spinal Injury Association (ASIA) as ASIA A.

Incomplete injury means there may be some ability to move or to feel below the level of injury. An incomplete injury is classified as an ASIA B, C or D type of injury, depending on the degree of neurological return:

- ASIA B – some degree of normal sensation in the areas below the injury but no muscular movement.
- ASIA C – sensation and some voluntary muscular movement in the areas below the injury.
- ASIA D – normal sensation and the ability to voluntarily move almost all the muscles in the areas below the injury.

The information in this manual primarily addresses the most severe (ASIA A) type of injury. If you have an incomplete injury, you may experience many of these problem areas but to a varying degree.

**EFFECTS OF SCI**

Each injury is different, even if X-rays of the fracture may appear similar. Some of the effects of spinal cord injury include the following:



**Movement and feeling** Depending on how complete or incomplete the injury, there can be a loss of the ability to move and to feel below the level of the injury. Chapter 9 will explain how SCI affects your muscles, joints and bones, what you should know about spasticity and heterotopic ossification and how SCI affects your ability to perform functional activities, such as feeding, grooming and walking. Chapter 6 explains how the changes in sensation affect the management of your skin.

**Spasticity** Injury to the spinal cord can cause involuntary muscle spasms and movements. These movements are actually reflexes that used to be controlled by inhibitory signals sent from the brain to the muscles. When these signals are disrupted, these reflex movements can occur. Spasticity is neither a good or bad thing, but if it interferes with function, medical treatment may be indicated. See Chapter 11 for more information.

**Circulation of the blood** SCI may cause low blood pressure. This may result in dizziness when you first sit or stand after being in a flat position. See Chapter 5 for more information about circulation.

**Temperature regulation** SCI affects your ability to regulate the temperature of your body below the level of injury. After an SCI, the part of the body below the level of injury may not be able to sweat normally (which cools the body by evaporation) or to shiver (which raises the body temperature). To learn how to safely regulate your temperature, see Chapter 5.

**Breathing** Damage to the spinal cord may result in difficulty in breathing. Chapter 9 will explain why your breathing may be affected and what you can do to prevent respiratory problems.

**Bowel functioning** SCI may cause changes in how your bowels empty. A properly regulated bowel-training program can prevent complications and inconvenience. Chapter 8 provides an explanation of these changes and ways to manage your bowels.

**Bladder functioning** SCI may cause changes in how your bladder empties. Proper bladder management can reduce complications. Chapter 7 provides an explanation of the changes in your bladder and ways to manage urination.

**Sexual functioning** Injury to the spinal cord may alter sexual function for men and women. Please see Chapter 14 for more information.

**Metabolic** Following an SCI, many chemical and metabolic changes occur in your body. One is the loss of protein from muscles, which can lead to weight loss, anemia and skin breakdown. Another change is calcium loss from the bones. Proper nutritional management becomes important after an SCI. See Chapter 10 for more information on nutrition.

**Autonomic dysreflexia** Autonomic dysreflexia affects persons with injuries at T-6 and higher. Autonomic dysreflexia is an exaggerated blood pressure response in combination with other symptoms that may occur as a result of an overfull bladder or bowel. You must learn to recognize and respond to the symptoms. See Chapter 5 for more information.

**Pain** There are many different types of pain that can result after SCI. If your injury was caused by trauma such as a car accident or a fall, you may have pain from broken bones, torn ligaments or swelling. If you had surgery to part of your body, swelling from the surgery and muscle soreness where the surgery was performed are typical causes of pain. Aching in your muscles after returning to exercise and activity can be normal during the rehab process. As you become more independent, it is also common to have shoulder or arm pain due to overuse of these muscles and joints. These are all examples of musculoskeletal pain. It is important to have this pain assessed to determine the cause and then treated appropriately. A different type of pain, neuropathic pain, can occur after a SCI. This pain is typically described as a burning, radiating or sharp

pain below your injury level. If any of these types of pain interfere with sleeping or other daily tasks, medical treatment may be indicated. Your treatment team will assist in identifying the cause of your pain and selecting an appropriate treatment.

**Swallowing** Problems with swallowing are not uncommon following a spinal cord injury. Weakened muscles in the mouth and throat can make it difficult to swallow. This difficulty swallowing is called “dysphagia.” If you are experiencing problems, your physician may refer you to a speech-language pathologist for a swallowing study. After testing, the physician and speech-language pathologist will determine the need for any precautions, exercises or special diets.

#### **Coexisting SCI and TBI (traumatic brain injury)**

Sometimes patients who have had traumatic injuries have both a spinal cord injury and a brain injury. The brain injury may be mild, moderate or severe. With a brain injury, it is likely that you will be unable to recall the accident or the events that occurred just after the accident. This gap in memory is called post-traumatic amnesia.

Some of the symptoms of a brain injury include difficulty paying attention, difficulty keeping track of time and place, difficulty remembering recent events, and word-finding problems. Other symptoms may include problems with judgment and reasoning, slower processing of information, personality change and mental fatigue.

If you or your family member notes any of these symptoms, or if you experienced a loss of consciousness at the time of your accident, your physician may ask a neuropsychologist to screen you for a brain injury. Your therapist or physician may be able to provide you with tools to assist you throughout your day.

Spinal cord injury results in many changes in your body. During rehabilitation, you will learn how SCI affects your body’s function, how to maintain or increase strength and endurance, how to perform tasks with special equipment, how to prevent complications and how to cope with these changes in your life. You will also learn that, despite limitations in your ability to move or carry out routine activities, you can pursue an active, productive and independent lifestyle.

### **HIGHLIGHTS**

- SCI may cause a variety of changes in your cardiovascular responses to movement, exercise and temperature below your level of injury.
- Autonomic dysreflexia results in a sudden increase in blood pressure and can be a **MEDICAL EMERGENCY**.
- The signs and symptoms of autonomic dysreflexia are: high blood pressure, severe headache, slow heart rate, flushed skin, blurred vision, goose bumps, nasal stuffiness, heavy sweating, pale skin, nausea and feelings of anxiety.
- The most important part of treatment is to find and relieve the cause of the autonomic dysreflexia.
- After a spinal cord injury, your circulatory system may not be able to transport blood as easily as before, and you may notice a change in your blood pressure readings.
- Problems you may experience include: feelings of light-headedness and dizziness, swollen feet and ankles, thrombophlebitis and skin breakdown.

### **AUTONOMIC CONTROL OF THE CARDIOVASCULAR SYSTEM**

Prior to spinal cord injury, heart rate and blood pressure are regulated by a part of the nervous system called the autonomic nervous system. The autonomic nervous system has two parts. One part maintains our resting heart rate and blood pressure; another part takes over in stressful situations. This is often referred to as our “fight or flight” response, which causes our blood pressure and heart rate to increase. Prior to a spinal cord injury, these two systems are able to interact with each other and control our cardiovascular system. Following a spinal cord injury at the T6 level or above, these two systems are NOT able to adequately work together.

### **EXERCISE CONSIDERATIONS FOLLOWING SPINAL CORD INJURY**

Following a spinal cord injury, the cardiovascular system may not be able to make the necessary adaptations to exercise, so that you can become more fit. This means that you will be able to increase the strength and endurance of the muscles that are working in your arms, trunk and/or legs, but you may not be able to decrease your resting heart rate and blood pressure through regular exercise. This also means that you may not experience an increase in heart rate and blood pressure as you exercise. In fact, some people with SCI experience a fall in blood pressure with increased activity.

A scale is used to measure your rate of perceived exertion; ask your therapist for a copy to help monitor your tolerance of an exercise program. This may better reflect your exertion than blood pressure and heart rate.

### **AUTONOMIC DYSREFLEXIA**

Autonomic dysreflexia can be a **medical emergency**, which may develop if you have a C-1 through a T-6 complete spinal cord injury. Autonomic dysreflexia is a nerve reflex that causes the blood vessels to get smaller. This, in turn, results in a sudden increase in your blood pressure. If this abnormal reaction is not stopped quickly, you may have a heart attack or stroke, and could die. The urgent need for treatment depends on the severity of the symptoms and your age.

### **SIGNS AND SYMPTOMS**

**It is extremely important to recognize the signs and symptoms of autonomic dysreflexia.**

They may include:

- High blood pressure (hypertension)
- Severe, pounding headache
- Slow heart rate (bradycardia)
- Flushing or red splotches of the skin above the level of the injury
- Blurred vision or appearance of spots in the visual fields
- Goose bumps above the level of the injury

- Nasal stuffiness
- Heavy sweating above the level of the injury
- Pale skin below the level of the injury
- Nausea
- Feelings of anxiety

**REMEMBER:** The pattern of symptoms associated with autonomic dysreflexia will almost always be the same in each episode. Learn to recognize these symptoms as soon as they start and begin treatment as quickly as possible.

### **MOST COMMON CAUSES OF AUTONOMIC DYSREFLEXIA**

- Distention of bladder (full, overstretched bladder) – the No. 1 cause of dysreflexia
- Urinary tract infection
- Bladder or kidney stones
- Bowel distention (caused by hard stools, constipation or inability to have a bowel movement)

### **OTHER POSSIBLE CAUSES OF AUTONOMIC DYSREFLEXIA**

- Excessive gas
- Enemas
- Suppository insertion, digital stimulation or manual removal of feces
- Irritated sore on the skin, pressure ulcers, scratches or abrasions, infected wounds or ingrown toenails
- Tight clothing, belts or external catheters
- Improper body positioning and infrequent weight shifts
- Excessive heat or drafts
- Surgical procedures and some diagnostic tests
- Instilling solutions or irrigating the bladder (as in radiology or urodynamic studies)
- Epididymitis or scrotal compression
- Gallstones, ulcers or hemorrhoids
- Menstruation, pregnancy (especially labor and delivery) or vaginitis
- Sexual intercourse, ejaculation
- Deep vein thrombosis or pulmonary emboli
- Burns or sunburn
- Blisters

- Insect bites
- Fractures or other trauma, heterotopic bone
- Pain
- Any painful or irritating stimulus below the level of the injury

### **WHAT YOU SHOULD DO IF YOU EXPERIENCE AD**

If you have symptoms of autonomic dysreflexia:

1. Sit up.
2. Check your blood pressure.
3. If the systolic or diastolic pressure is more than 20-40 mm Hg above the normal level, sit up immediately or raise the head of the bed. If you are in your wheelchair, transfer to the bed immediately and raise the head of the bed. Loosen clothing and constrictive devices.
4. Then, find and remove the cause.

Check your bladder:

- If you are on an intermittent catheterization program, catheterize slowly. Emptying the bladder too fast may cause spasms and increased blood pressure.
- If you have an indwelling catheter, check the tube for kinks, twists and improper drainage. If the catheter is not kinked or twisted and it is not draining, irrigate the tubing. If you cannot irrigate the catheter, you will need to change the catheter.
- If you wear an external catheter, be sure that it is not twisted.
- Empty the drainage bag if it is full. If none of the above corrects the problem, check the bowel:
- Squeeze about an inch of anesthetic ointment (such as Dibucaine or Nupercaine) into the rectum. Wait for five minutes.
- Check for large amounts of stool in the rectal vault and remove, if present.
- After the symptoms of dysreflexia resolve, follow a bowel cleansing program (according to your physician's recommendation). **Do not take an enema when you are having symptoms of dysreflexia.**

If you are still experiencing signs of autonomic dysreflexia, look for problems with the skin:

- Pressure sores, painful stimuli (cuts, bruises, burns, sunburn, or pressure on the body) or ingrown toenails.
- Too tight clothing – if so, then loosen.
- Irritation from cuts, bites or burns – reduce with a cold cloth or medication.

**5. If symptoms persist, go to an emergency room or call 911.** Be sure to have your Medical Alert card in your wallet.

**REMEMBER:** The symptoms of autonomic dysreflexia do not go away unless you remove the cause. If you have a prescribed medication to lower your blood pressure, do not take it until you have tried all measures to eliminate the cause. If your autonomic dysreflexia is caused by something that is not easily corrected, you may need to control your blood pressure with the medication until the cause is effectively treated.

#### **PREVENTION OF AUTOMATIC DYSREFLEXIA**

Autonomic dysreflexia can often be avoided if you follow the basics of good self-care:

- Keep your bladder well drained by using an indwelling catheter, suprapubic catheter or an intermittent catheterization program.
- Keep your leg bag or drainage bag properly placed. Do not allow the bag to become over-filled.
- Maintain a routine and thorough bowel program.
- Take all medications as prescribed by your doctor.
- Regulate fluid intake as necessary.
- Perform skin checks at least two times a day.

#### **CHANGES IN YOUR CARDIOVASCULAR SYSTEM**

The circulatory system consists of a pump (the heart) and two major types of blood vessels (see Figure 5.1):

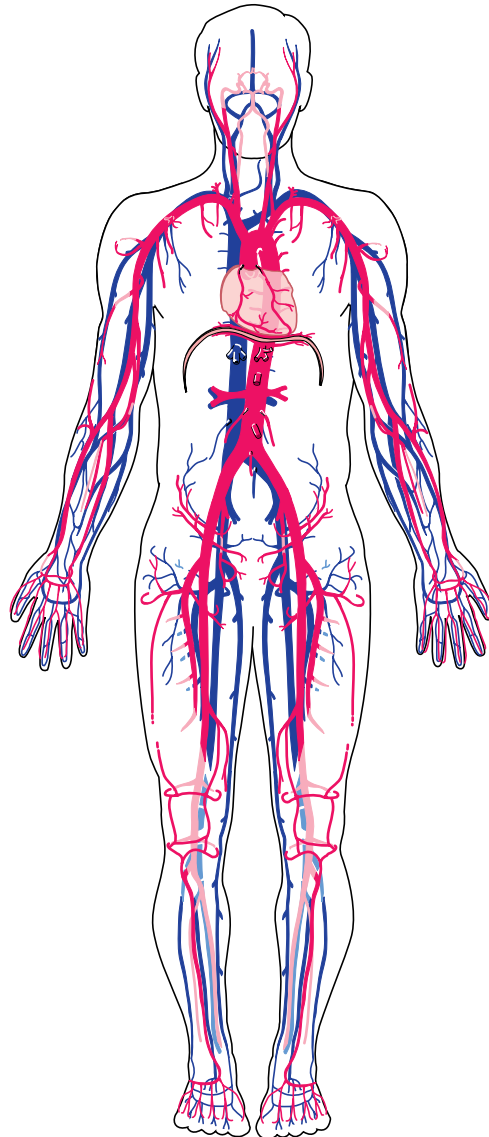

**Figure 5.1** Circulatory System. Heart, artery and veins.

The **arteries** carry blood with oxygen from the heart to the rest of the body.

The **veins** carry the blood back to the heart so that it can be pumped through the lungs to receive oxygen again. After receiving oxygen through the lungs, the blood returns to the heart and is carried to the rest of the body through the arteries.

This continuous cycle of pumping blood from the heart through the arteries and veins and back to the heart is called **circulation**. The flow of blood is dependent upon the heart rate and blood pressure.

After a spinal cord injury, you will notice changes in your muscle tone and circulation. With paralysis or partial paralysis, your circulatory system may not be able to transport blood as easily or efficiently as before. You may notice that your blood pressure levels are lower than previous levels. Depending on the level of your injury, you may experience certain problems with your circulation:

- Feelings of light-headedness and dizziness when changing position from lying down to sitting upright
- Swollen feet and ankles
- Thrombophlebitis (inflammation of a vein accompanied by a venous blood clot)
- Skin breakdown

With proper precautions and self-care, you can prevent many of these complications:

#### **Light-headedness and Dizziness**

When you are in a lying position and sit up suddenly, your blood pressure drops causing you to feel light-headedness and dizziness, or even to “pass out” briefly. This drop in blood pressure related to change in body position is called “orthostatic hypotension.” To give your body enough time to make the adjustment from a lying to a seated position, raise the head of the bed about 30 degrees. Stay in that position for at least 15 minutes before getting up. If you can’t raise the head of the bed, prop yourself up with pillows before getting out of bed. Also, **wearing elastic stockings and an abdominal binder may help prevent the blood from collecting in the lower part of your body.**

#### **Signs and Symptoms of Orthostatic Hypotension/ Low Blood Pressure**

- Feeling light-headed and/or dizzy
- Feeling faint

- Decreased face/lip color; no longer pink but turning pale or lighter color
- Blurred or dimmed vision
- Difficulty hearing
- Cool, clammy, sweaty

Overcoming orthostatic hypotension takes time. Prior to spinal cord injury, your body relied on the pumping of the muscles in your legs and abdominals to return the blood from your legs back to your heart when you were sitting or standing. With paralysis or partial paralysis, your leg and/or abdominal muscles are not able to contract to push the blood back up to the heart.

#### **What You Should Do**

If you are sitting in your wheelchair and get dizzy:

- Check your blood pressure.
- If possible, elevate the leg rests.
- Tilt the wheelchair back as instructed by your therapist.
- Stay hydrated.

#### **Swollen Feet and Ankles and Skin Ulcers**

Due to paralysis, decreased pressure in leg veins slows the return of the blood to the heart, causing your feet and ankles to swell, especially when sitting. When circulation is poor, the skin has a greater tendency to break down, and the resulting skin breakdown may heal very slowly. Exercising, elevating your legs, wearing elastic stockings and an abdominal binder may help reduce swelling and poor circulation.

#### **Thrombophlebitis**

Phlebitis is inflammation of a vein, and thrombophlebitis is inflammation of a vein accompanied by a venous blood clot (thrombus). If a clot breaks away from a vein, it can travel to your heart or lung and be life-threatening. Blood clots form for various reasons and are more likely to occur in the lower part of the body. You may also hear the term DVT, which stands for deep vein thrombosis.



### **How to Maintain Good Circulation**

Remember these points to maintain good circulation:

1. Clots in the veins occur most often in the legs, above the knee rather than in the calves, and more often in the left leg. Therefore, leg bags, which are used to collect urine, are best worn below the knee on the right leg.
2. When too much pressure is placed behind the knees, the arteries and veins can become blocked. Pressure develops if elastic hose slip down or become tight behind the knees. Wheelchair footrests that are too low can also lead to increased pressure to the veins and arteries in the back of the legs. Be sure that wheelchair footrests are properly adjusted.
3. Prolonged bed rest can slow circulation and increase the chances that clots will form in your veins. To prevent the formation of blood clots and improve circulation, use a soft flat pillow lengthwise underneath your legs, placing it from the middle of the thigh to the ankles. Avoid putting direct pressure right behind the knees. Be sure that your heels are supported and are free from pressure.
4. Proper nutrition helps maintain good circulation. A well-balanced diet will help ensure that your body is functioning at its best. See Chapter 10 for guidelines on proper intake of fluids and foods.
5. Prolonged sitting in a wheelchair can cause excessive pressure to sitting surfaces. It is important that you do hourly weight shifts as part of your daily activities. This will improve circulation to your skin and buttocks and help prevent pressure ulcers. See Chapter 6 for more information.
6. Doing exercises on a daily basis can improve general circulation. Work out a plan of exercises with your therapist(s) and doctor. See Chapter 11 for more information.

### **FOOT AND TOENAIL CARE**

Proper foot and nail care is often ignored in routine hygiene. Your feet require extra care because they are the body parts farthest from the heart and get less blood. Pressure on the toes caused by ingrown toenails or shoes that are too tight can prevent good circulation.

Moisture encourages fungus growth, so it's important to keep your feet dry at all times. A white color around the nails or toenails that have become very thick are both signs of fungal infection.

Swelling of the feet may interfere with blood flow in the feet. Raising your legs on pillows or wearing elastic stockings helps prevent swelling.

Proper care of your feet and toenails includes:

- Inspecting your feet and nails daily for any problems.
- Using gentle pressure when rubbing your feet or doing nail care to prevent accidental injury.
- Soaking your feet in warm water (test the temperature first or have someone check it for you).
- Consulting a podiatrist (foot specialist) if you think you have a problem with your feet or nails.

**HIGHLIGHTS**

- Following a spinal cord injury, you must pay special attention to your skin.
- After your spinal cord injury, you may not be as aware of pressure on your skin.
- Skin breakdowns, decubitus ulcers, bedsores and pressure ulcers are all names for an area of dead skin tissue caused by increased pressure on a small area of soft tissue. These skin breakdowns can occur with prolonged pressure occurring over a very short period of time – in as little as one hour.
- You can maintain healthy skin by practicing the following:
  - Keep your skin clean and dry.
  - Do regular skin checks and weight shifts.
  - Use proper transfer techniques.
  - Eat a balanced, nutritious diet.
  - Drink plenty of water (except as restricted).
  - Use the appropriate pressure-reducing seat cushion.
  - Wear properly fitted clothing and shoes.
  - Avoid using tobacco and alcohol.
  - Keep your stress level under control.
- Early signs of pressure ulcers that you need to watch for include:
  - Change in skin color
  - Burns
  - Rashes
  - Swelling
  - Pimples and ingrown hairs
  - Bruises
  - Breaks in the surface of the skin

**PURPOSE OF THE SKIN**

Your skin is a major organ of your body, just like your heart, lungs and kidneys. After a spinal cord injury, you must pay special attention to your skin to prevent breakdown.

Your skin has several major purposes:

- To protect your body from the harmful effects of the environment, such as dirt, the sun's ultraviolet rays, bacteria and other microorganisms.
- To act as an important sensory surface, giving you information about what is touching you, such as whether something is hot, sharp, etc.
- To help regulate your body's temperature and fluid balance.

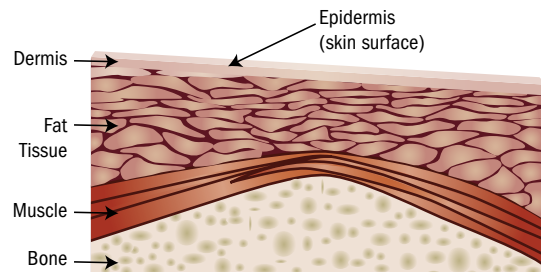

**Figure 6.1a** Normal skin

The skin has two major layers (see Figure 6.1a): the outer layer, called the epidermis; and the inner layer, called the dermis. The epidermis contains cells that cover the surface of the body and line its cavities. The dermis consists of a dense bed of blood vessels and tissue made up mainly of protein. The fat tissue, muscle, bone and internal organs are below the dermis.

**HOW A SPINAL CORD INJURY AFFECTS YOUR SKIN**

In an intact nervous system, nerves send messages of feelings, such as pain or burning, to your brain to let you know that you need to move or change your position. You automatically change position and seldom have to think about it. Now, because your spinal cord has been injured, some messages of discomfort may not reach your brain. You may not be aware when your skin has been exposed to too much heat, pressure or other stimuli. To adjust to this change, you have to think about the things that may harm your skin even though you may not feel them.

After a spinal cord injury, your circulation is also affected. This puts your skin at even greater risk. Inadequate circulation results from a decrease in movement or muscle action. Blood may pool in your legs from sitting for prolonged periods of the time.

In addition, your body does not use proteins as efficiently as before your injury, causing the loss of muscle mass and a decrease in the ability of the skin to heal itself after it has been damaged.

### **PRESSURE ULCERS**

Skin breakdown, decubitus ulcers, bedsores and pressure ulcers are all names for an area of dead skin tissue. Pressure ulcers are caused by increased pressure on an area of soft tissue.

When pressure is applied to your skin, blood is cut off to that area. Oxygen and other substances, which are carried in the blood, do not get to the skin. Without the blood supply, the skin dies. The dead area becomes a pressure ulcer.

When the pressure is over a bony area, such as the ischium (“seat” bone) when sitting or the heel when lying down, the decreased blood supply is even more evident. The skin over bony areas is at even higher risk of developing a pressure ulcer.

The primary causes of pressure ulcers are:

- Pressure
- Shearing or friction
- Trauma
- Spasticity
- Moisture

**Pressure** Pressure may result from sitting too long without moving, poor positioning in bed or in your wheelchair, worn-out mattresses or wheelchair cushions, poorly fitting wheelchairs or tight-fitting clothes or braces.

**Trauma** Trauma may be from poor transfer techniques, riding over rough terrain or falling.

**Moisture** Moisture may be from sweat, urine, stool or other sources, including rain.

**Shearing or friction** Shearing forces or friction may be from dragging yourself across a surface, slouching in your wheelchair or sitting at an angle in bed.

**Spasticity** Spasticity may cause pressure or shearing forces on the skin as well as bumping or rubbing of body parts, all of which can lead to skin breakdown (see Chapter 11).

**NOTE:** Fever or illness, such as urinary tract infections, flu or stomach viruses, that may seem unrelated, can also lower your skin’s ability to tolerate pressure by lowering the body’s level of resistance.

### **CONSEQUENCES OF PRESSURE ULCERS**

If you develop a pressure ulcer, the healing process may take six or more months. Your activity may be restricted (no sitting in bed or wheelchair), and you may be hospitalized. Pressure ulcer treatment can be physically, financially and emotionally devastating.

### **RECOGNIZING AND TREATING PRESSURE ULCERS**

Skin breakdown is typically described in four stages or grades. Each stage refers to the amount of tissue damage. Your doctor will prescribe treatment based on the stage of the pressure ulcer.

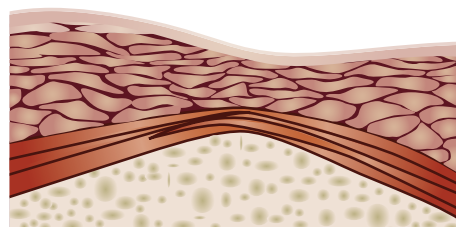

**Figure 6.1b** Stage 1: Involves superficial skin tissue.

#### **STAGE 1**

A Stage 1 pressure ulcer is a change in an area of skin that:

- May be red or darkened. The redness or discoloration does not disappear within 20 minutes. Area does not blanch (become lighter) when pressed (see Figure 6.1b).
- Appears as a defined area of persistent redness in lightly pigmented skin, whereas in darker skin

tones, the ulcer may appear with persistent red, blue or purple hues.

- Has a different skin temperature (warmth or coolness), tissue consistency (firm or boggy feel), or sensation (pain, itching)

A Stage I pressure ulcer usually disappears within one to seven days after the pressure is removed.

### Treatment of Stage 1

- Determine and remove the cause of the pressure or shear force.
- Keep pressure/shear force completely off the affected area until the skin returns to normal.
- Increase the protein in your diet as prescribed.

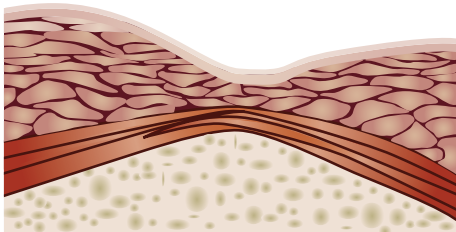

**Figure 6.1c** Stage 2: Involves skin tissue down into fat tissue.

### STAGE 2

Once a pressure ulcer has progressed to Stage 2:

- Several tissue layers of skin down to the underlying fatty tissue are involved.
- The surface of the skin is broken.
- The surrounding area is red or darkened and swollen.

### Treatment of Stage 2

- Medical treatment is necessary. Consult your doctor.
- Keep pressure/shear force off the affected area. If the affected area is on a sitting surface, do not sit, even while in bed.
- Eat more high-protein foods as prescribed.
- Inspect bathroom equipment, wheelchair cushion, bed surface and clothing for the sources of pressure or shear force.
- Review your technique and schedule for positioning yourself in the bed or in the chair.
- Keep your skin clean and dry.

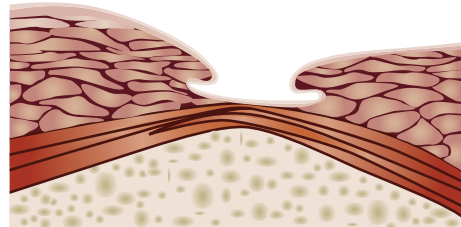

**Figure 6.1d** Stage 3: Destroys skin and fat tissue, possibly into muscle.

### STAGE 3

In a Stage 3 pressure ulcer:

- Skin is broken and fatty tissue is destroyed.
- Muscle may also be involved.
- Infection may exist.

### Treatment of Stage 3

- Requires medical treatment and may need surgical repair or surgical removal of dead tissue.
- Keep pressure/shear force off the affected area. If the affected area is on a sitting surface, do not sit.
- Ask your doctor or nurse about additional ways to reduce pressure and shear force, such as a special pad or mattress.
- Eat more high-protein foods.
- Practice good hygiene.
- Apply dressings to the ulcer, as ordered by your doctor.

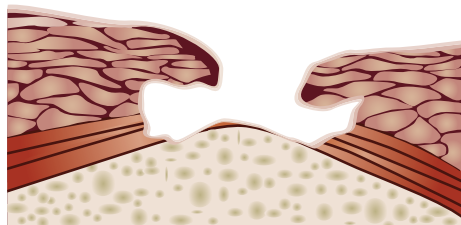

**Figure 6.1e** Stage 4: Destroys skin, fat and muscle tissue and possibly bone.

### STAGE 4

In a Stage 4 pressure ulcer:

- There is a deep sore with skin, fatty tissue, muscle and possible bone involvement.
- Black scab/scar may be present.
- Infection may exist in either the tissue or bone.

**Treatment of Stage 4**

- Requires medical treatment and may need surgical repair.
- Keep pressure/shear force off the affected area. Do not sit if the affected area is a sitting surface.
- Increase the amount of high-protein foods you eat.
- Talk with your doctor about treatment.
- Apply dressings to ulcer as ordered by your doctor.

**WHAT YOU SHOULD DO**

**Maintaining Healthy Skin**

If you do not take care of your skin, you may develop a pressure ulcer or other types of skin breakdown. Here are some ways to avoid skin breakdown and maintain healthy skin:

- Practice good personal hygiene.
- Avoid burns.
- Avoid tight clothing, shoes and bed linens.
- Position yourself properly in bed and in the wheelchair (see Figures 6.2a - 6.2l).
- Practice weight shifts and pressure relief (see Figure 6.3a - 6.3k).
- Practice proper transfer techniques (see Chapter 12).
- Maintain good nutrition.
- Prevent joint contractures.
- Avoid alcohol, drugs and tobacco.
- Avoid psychological stress.

**Bed Positioning**

Remember, proper positioning in bed is crucial for maintaining healthy skin. Consult your therapist, nurse or physician for specific instructions regarding your positioning program and turning schedule.

Bed positioning is important for:

- Skin protection
- Joint protection (especially for shoulders, shoulder blades, elbows, hips, knees and ankles)
- Management of swelling

**Pressure points lying down**

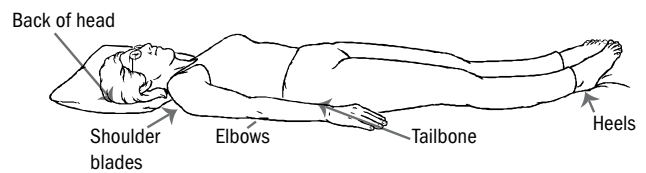

Figure 6.2a

**Pressure points on your side**

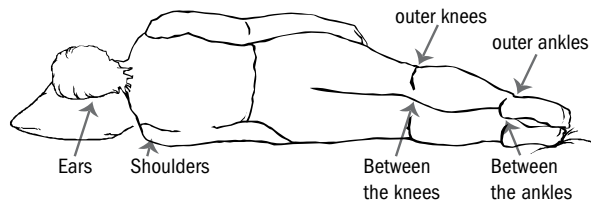

Figure 6.2b Pressure Points Lying on Your Side



Figure 6.2c Pillow Placement under calves (and heels) to lift heels so there isn't any pressure on the heel.



Figure 6.2d Lying on back, palms down, pillows support head and arms and relieve pressure on heels.



Figure 6.2e Quarter lying on side. Pillow at back to keep you rolled off your tailbone. Pillows to support arms.





**Figure 6.2f** Quarter lying on side. Pillows between bony knees and ankles. Top leg isn't resting directly over bottom leg.



**Figure 6.2g** Quarter lying on side. Pillows between bony knees and ankles. Top leg isn't resting directly over bottom leg.



**Figure 6.2h** When quarter lying on side lower body is rotated over to take pressure off tailbone.



**Figure 6.2i** Upper body still relatively flat so there isn't direct pressure on the shoulder.

**Weight Shifts**

You must make “weight shifts” a conscious part of your daily routine.

The guidelines most often followed are:

- Do a weight shift every 30 minutes for a duration of 30 seconds.
- OR
- Do a weight shift every hour for a duration of 60 seconds.

The weight shifts can be done in a variety of ways, depending on your physical capabilities. The types of weight shifts are:

- Wheelchair push-ups, usually performed independently (see Figures 6.3b and 6.3c).
- Leaning side-to side, independently (see Figure 6.3d or 6.3e).
- Leaning forward, independently (see Figure 6.3f or 6.3g).
- Tilted back, assisted if you use a manual wheelchair (see Figure 6.3h) or independently if you use a power tilt in space chair (see Figure 6.3i).
- Reclined, assisted if you use a manual chair (see Figure 6.3k) or independently, if you use a power recline chair (see Figure 6.3j).

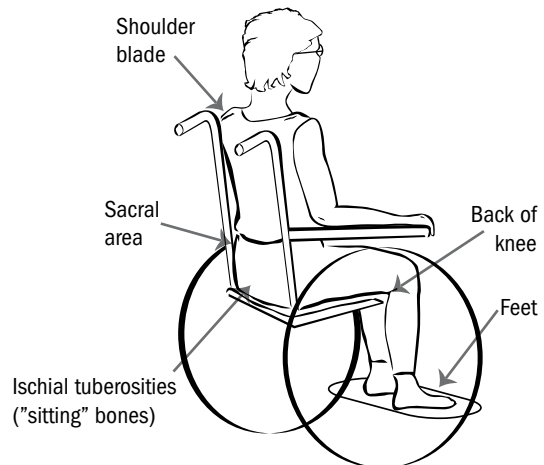
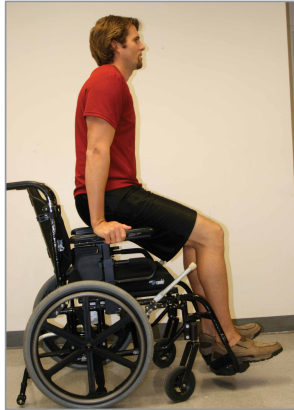

**Figure 6.3a** Pressure Points While Sitting





**Figure 6.3b**  
Push up weight shift.



**Figure 6.3c**  
Push up weight shift.



**Figure 6.3h** Tilt back with assist in manual wheelchair.



**Figure 6.3d**  
Side lean without legs crossed.

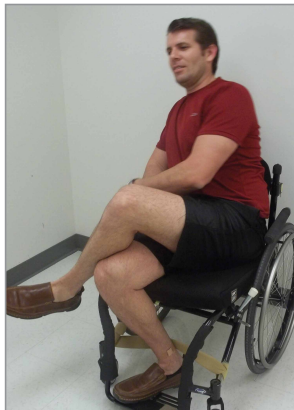

**Figure 6.3e**  
Side lean with legs crossed.



**Figure 6.3i**  
Tilt back in power wheelchair.



**Figure 6.3j**  
Reclined back in power wheelchair.



**Figure 6.3f** Lean forward with-  
out support.



**Figure 6.3g** Leaning forward  
with support of raised hospital  
bed or back of sofa.



**Figure 6.3k** Reclined with assist in manual wheelchair.

**Checking Your Skin**

You should examine your skin every morning and every evening for changes in color, texture or temperature. In the morning, a skin check will tell you if your position in bed or bed clothes (pajamas, sheets and pillows) have caused any skin changes during the night. In the evening, a skin check will tell you if the clothes that you wore that day, the day’s transfers or sitting have caused any changes in your skin.

Each person’s skin will react to pressure in a different way. It’s important that you become familiar with your normal skin color so that subtle changes can be observed before major tissue damage

occurs. If you have dark-colored skin, signs of pressure are harder to see. Feel the skin gently for warmth, swelling, hardness or a macerated (soft, mushy) feeling. If you are not able to see certain areas on your body, it may be necessary to use a mirror, or rely on your caregiver to give you a specific description of what your skin looks like.

Early signs of pressure ulcers that you need to watch for include:

- **Change in color of the skin**

- Burns
- Rashes
- Swelling
- Pimples and ingrown hairs
- Bruises
- Breaks in the surface of the skin

**A change in skin color or texture that lasts more than 20 minutes should be considered dangerous and the area kept free of pressure until it returns to “normal.”**

Maintaining healthy skin requires your alertness and constant attention. Practice good habits by:

- Keeping your skin clean and dry
- Doing regular skin checks and weight shifts
- Using proper transfer techniques
- Eating a balanced nutritional diet
- Drinking plenty of water
- Using the appropriate pressure-reducing seat cushion
- Wearing properly fitted clothing and shoes
- Avoiding tobacco, alcohol and high levels of stress

**HIGHLIGHTS**

- With SCI, you have a neurogenic bladder, which means that your bladder is unable to empty itself of urine. The types of neurogenic bladder that occur with SCI are either reflex or non-reflex.
- Some options for bladder management following an SCI include:
  - Intermittent catheterization program
  - Indwelling (Foley) catheter
  - Suprapubic tube
  - Other surgical options
- Signs of a bladder infection may include:
  - Increased spasticity
  - Leaking between catheterizations
  - Strong, rancid-smelling urine
  - Discolored urine
- Autonomic dysreflexia is a potentially life-threatening abnormal response or nervous system reflex and should be considered an emergency. The most frequent cause of autonomic dysreflexia is over-stretching the bladder.
- Almost every SCI patient will see a urologist who specializes in neurogenic bladders.
- Your physician may order various studies to evaluate the best method for managing your bladder.

**URINARY SYSTEM**

The urinary system is made up of the kidneys, ureters, urinary bladder, urinary sphincters and the urethra (see Figure 7.1).

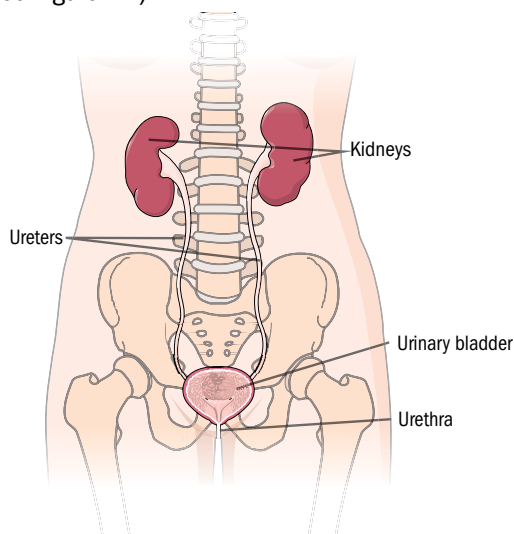

**Figure 7.1** Female Urinary System.

**Kidneys**

Your two kidneys filter waste from the body and form urine. They also regulate water and electrolytes. If the kidneys are not working properly, waste products in the blood can build up, leading to a life-threatening situation.

**Ureters and Urinary Bladder**

The ureters are narrow tubes that carry urine from the kidneys down into the urinary bladder. The urinary bladder is a round organ made up of muscle that expands as the bladder fills up and contracts to empty the bladder. It can hold between 350 to 450 cc of urine (approximately 1½ cups) before it is ready to empty. Due to its flexibility, it can stretch to hold a much larger amount of urine, but if the bladder is allowed to overfill, the bladder will become overstretched. If this occurs too often, the bladder muscle may become less flexible and lose its ability to work properly.

**Urethra**

Urine passes from the bladder out of the body through a tube called the urethra. In men, this tube is about 6 to 8 inches long. Its outer opening, or urinary meatus, is at the tip of the penis. In women, this tube is about 1 to 2 inches in length. The urinary meatus is located just above the vagina.

**Sphincters**

Two special muscles called sphincters control the flow of urine through the urethra to the outside of the body. The internal sphincter, which is controlled by nerve reflexes, is at the “neck” or base of the bladder. The external sphincter is a well-defined muscle that surrounds the urethra, and is located below the prostate gland in males. In females, it surrounds the middle of the urethra.

The external sphincter is controlled voluntarily (consciously). It usually stays tightly closed until it receives the proper signal from the nervous system to relax and allow urine to flow out of the bladder.

**HOW DOES THE BLADDER WORK?****Non-neurogenic Bladder**

If you have a non-neurogenic (voluntary) bladder, it responds properly to brain signals to urinate or prevent urination. When you're ready to empty your bladder, your brain sends it messages to squeeze down and to relax your sphincter muscles.

**Neurogenic Bladder**

With SCI, you have a neurogenic (non-voluntary) bladder, which means that your bladder is unable to empty itself of urine. The types of neurogenic bladder that occur with SCI are either reflex or non-reflex.

**Reflex Neurogenic Bladder**

If your spinal cord is damaged at L-1 level or above, you are likely to have a reflex bladder. The brain is unable to receive signals that the bladder is full and to send signals to empty the bladder (Figure 7.2). A reflex arc is established between the bladder and the spinal cord below the level of injury. This reflex arc attempts to sense when the bladder is full and by reflex attempts to contract the bladder musculature to empty. This is called a reflex bladder.

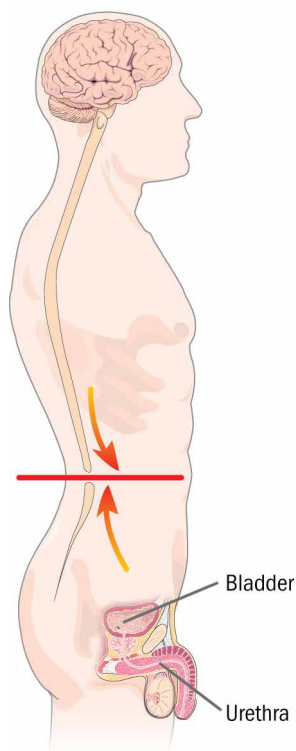

**Figure 7.2** Reflex Neurogenic Bladder. At the level of injury, messages to and from the bladder are blocked by injury to the spinal cord.

Reflex emptying is not normal. If you have reflex emptying, you may not be able to sense when the bladder is full. You may have severe contractions and a lot of pressure in your bladder. Also, you may not be able to relax the sphincter when your bladder is contracting.

Your doctor may order urodynamic studies to see if there are any abnormalities in bladder functioning. Results of the studies will help your physician determine proper management of your bladder function.

**Non-reflex (Flaccid) Neurogenic Bladder**

If your spinal cord is damaged at the L-1 level or below, you may have a non-reflex bladder. With this bladder condition, nerves that connect your spinal cord to your bladder have been damaged. Therefore, when your bladder is filled with urine, it is unable to contract normally to allow you to urinate and empty. As a result, your bladder may become overstretched and urine may dribble out or “overflow.” This urine leakage most often occurs when straining, such as while performing weight shifts in the wheelchair.

**Positional Changes**

Turning or changing position may help empty your bladder of urine. Be aware of which position helps you to empty your bladder the best.

**CHANGES IN URINE VOLUME****High Volume of Urine**

The amount of urine your kidneys produce may vary, but usually your urine production equals the amount of fluid you drink. Drinking large quantities of fluids will increase the amount of urine you produce. Your kidneys may also produce more urine when you are lying down for long periods, like at night, because your heart works more easily when you are lying down, and more blood is pumped through your kidneys.

Increased urine production helps you get rid of extra fluids that collect in your legs when you're out of bed. Beverages that contain alcohol or caffeine (e.g., coffee, dark-colored sodas and tea) can cause your kidneys to produce more urine. Chocolate products in any form also contain caffeine.



**Low Volume of Urine**

Your kidneys will produce less urine if you are losing body fluids through:

- Your lungs when you breathe rapidly during exercise
- Your gastrointestinal tract when vomiting or diarrhea occurs
- Your skin when you sweat

If you have lost water from your body for any of the above reasons, you may need to drink more fluids to maintain your fluid balance and prevent dehydration. Check with your doctor if vomiting prevents you from taking in fluids.

**Excessive Residual Urine**

Excessive residual urine volume can be measured by a bladder scan or by passing a catheter into your bladder within 10 minutes after it releases urine. This is called “post-voiding” residual urine volume, which is the amount of fluid that remains in the bladder after voiding. The difference can help you find out how well your bladder and urethral sphincters are working together.

**OPTIONS FOR BLADDER MANAGEMENT****Intermittent Catheterization Program (ICP)**

Following a spinal cord injury, you’ll need to empty your bladder on a regular basis to avoid overfilling and overstretching. One way to empty your bladder is intermittent catheterization, accomplished by inserting a straight catheter at regular intervals into the bladder to drain the bladder of urine.

Intermittent catheterization avoids the prolonged trauma, irritation and/or possible infections from a catheter staying in the urethra and bladder 24 hours a day. Your doctor will order specific times for catheterization depending on the volume of your regular fluid intake and on how your urinary system is working.

While you’re in the hospital, you’ll begin with sterile technique to perform intermittent catheterization to avoid possible infection by hospital bacteria. Before you return home, we will teach you intermittent catheterization using clean technique. Most patients continue to use this method after discharge. This involves thoroughly cleaning and preparing your genital area and thoroughly cleaning your catheter and other equipment you use. Your nurse will provide specific instructions on how to perform intermittent catheterization, including clean technique.

**Indwelling (Foley) Catheter**

An indwelling catheter is a type of catheter with a balloon at the end of the tip. When the catheter is inserted into the bladder, the balloon is inflated to hold it in place, allowing the urine to drain continuously. It’s important that there are no loops or kinks in the tubing that might restrict the flow of urine into the drainage bag. The indwelling catheter is typically changed every 30 days.

**Suprapubic Tube**

A suprapubic tube also drains the urine continuously from the bladder. It is a soft rubber catheter (tube) that goes through the skin of the lower abdomen and into the bladder. The catheter is placed through a long-term opening in the bladder called a stoma. The catheter is held inside the bladder by a balloon on one end. This balloon is filled with air once the catheter is inside the bladder and in the correct position. It is connected to a plastic tube that leads to a bag where the urine stays until it is emptied into the toilet.

**EXTERNAL CATHETERS (MALES ONLY)**

An external catheter is a synthetic rubber-like device, similar to a condom, that is applied to the shaft of the penis. Tubing from the external catheter allows the urine to drain from the bladder to a leg bag or bedside bag. The external catheter is used when urinary incontinence is a problem, when indwelling catheterization is no longer medically safe or when there is leakage between intermittent catheterizations. It may also be used if your bladder empties reflexively with less than two ounces of residual urine.

If you wear a disposable external catheter, change it daily. If you wear reusable type, we recommend that you have at least two or more to alternate from day to day.

Before applying an external catheter, be sure that your genital area is clean and dry. Use the size and brand of external catheter that works best for you. Medical equipment companies or some drug stores offer a variety of brands. Experiment with different adhesives to find the one that holds the catheter in place and prevents leaking.

Your urinary program will be monitored closely to see if you can continue using an external catheter. An indwelling catheter may be reinserted temporarily if you develop a urinary infection.



**Preparation Before Applying External Catheter**

1. Wash your penis with soap and water. Use care in cleaning the meatus and, if you are not circumcised, the foreskin. Pull back the foreskin toward the body. Wash and dry. Return the foreskin back over the end of the penis.
2. Rinse well, and gently dry with a towel.
3. Observe your genital area closely for rashes or skin irritations, especially where the external catheter comes into contact with your skin.
4. Wait 10 to 15 minutes (air dry) before reapplying a new catheter.

(Note: You may need to place your penis in a urinal or in a towel roll if dribbling is a problem.)

**Hints About Catheters**

Check the catheter and tubing every one to two hours to make sure they are not twisted and are draining well. They will stop draining if they become twisted.

Wear your leg bag below your right knee or on the right lateral (outside) thigh, unless instructed to wear it on the left side. Be sure that the leg bag straps are not too tight.

If you choose to wear undergarments, wear boxer shorts, instead of jockey shorts. Boxer shorts are less binding and less likely to cause a kink in the catheter tubing at your groin.

You may keep your leg bag on when in bed for a short time (less than an hour). If you are in bed longer than an hour, connect the catheter to the larger bedside bag as the urine will drain better.

As you experiment, you will find the best way to wear and care for your external catheter.

**Surgical Options for Bladder Management**

Any recommended surgical procedure will depend on the individual findings of your diagnostic urologic studies (urodynamics), as well as lifestyle decisions made by you and the urologist.

Some types of surgical procedures currently available include:

**Artificial urinary sphincter** involves implanting a silicone ring that is passed around the urethra or the bladder neck and connected to a pump that goes in the scrotum or labia and to a reservoir placed in the lower abdomen. The pump is squeezed by hand to inflate or deflate the silicone ring. The procedure is for patients with urethral weakness and incontinence.

**Bladder augmentation** involves surgical removal of a portion of the bladder wall, replacing it with a portion of intestinal wall. This decreases severe bladder contractions.

**Bladder neck incision** involves cutting the muscular ring at the base of the bladder that helps control urine flow. This is done through the urethra.

**Continent diversion** is a major surgical procedure that involves creation of a new bladder, using the patient's bowel and sometimes portions of the patient's bladder, to create a reservoir to hold urine. The reservoir is connected to an opening in the abdominal wall that maintains continence while allowing intermittent catheterization.

**Ileovesicostomy** refers to surgical construction of an artificial urethra using a piece of intestine to divert urine from the bladder to an opening through the lower abdominal wall.

**Pubovaginal sling** is a surgical procedure for women who have urethral weakness that results in loss of urine through the urethra. The surgery uses the patient's own tissue to sling around the urethra and help maintain closure.

**Sphincterotomy** is the surgical incision of the external sphincter muscle to allow better passage of urine, especially when this muscle is very tight or spastic.

**Spinal cord stimulator/implant** (Vocare) is a surgical procedure in which a stimulator is placed under the skin in the lower abdominal wall. It is connected by a wire that travels underneath the skin to electrodes placed around specific nerves coming out of the lower portion of the spinal cord. The procedure allows the patient to void on demand and continent, and may resolve dysreflexia.

**Suprapubic (SP) tube** is the surgical insertion of a tube (catheter) through the lower abdominal wall into the bladder. This procedure is reversible.

**Urethral stent** is an alternative to sphincterotomy. A wire mesh stent (tube) is non-surgically placed in the urethra at the level of the external urethral sphincter, enabling better flow of urine when the sphincter is very tight or spastic.

If your urologist suggests any of the above procedures, you will be given more detailed information, including benefits and complications.

## POSSIBLE COMPLICATIONS AFTER SCI

### 1. Infection

#### ◆ Bladder Infection

After a spinal cord injury, the symptoms of an acute bladder infection are usually less noticeable than before your injury. It is important to know when you are experiencing signs and symptoms of a bladder infection.

Bladder infections can occur in many ways. Bacteria can enter the bladder through or around a urinary catheter, leading to an infection of the bladder. If your overall state of health is “run down,” you may be more susceptible to an infection.

Some possible symptoms of a bladder infection are:

- Increased spasticity
- Leaking between catheterizations
- Feeling of weakness or lack of energy
- Foul smelling-urine
- Low-grade fever

Other signs and symptoms of a bladder infection are:

- A burning feeling or pain when you pass urine (if you have sensation).
- A strong rancid or fish-like smell. Sometimes foul-smelling urine is the temporary result of ammonia from standing urine, or from eating certain foods or taking certain medications. Concentrated, cloudy or foul-smelling urine can be managed by an increased fluid intake.
- If the bladder wall becomes irritated by infection, the urine may appear the color of tea or cola, or blood-tinged. Please note: Certain types of drugs can also change the color of the urine.
- Thick stringy white sediment that looks like pus. However, not all sediment indicates a urinary tract infection.

It is important to know that bacteria may be present in the bladder without causing an infection. If you are not experiencing symptoms, your physician may decide not to treat the bacteria with antibiotics.

#### ◆ Kidney Infection

If the bacteria migrate upward into your kidneys, a kidney infection can result. Signs of a kidney infection include:

- Shaking chills
- Cold sweats followed by high fever
- Dry mouth
- Weak, fast pulse
- Low blood pressure
- Marked decrease in the amount of urine output
- Nausea and vomiting
- Headache
- Blood-tinged urine

A severe kidney infection needs immediate treatment. If you are unable to reach your regular physician, go to the nearest emergency room.

#### ◆ Controlling Bladder and Kidney Infections

To prevent germs from entering the bladder, make sure that everything that comes in contact with the external urethral opening is clean. To accomplish this:

- Wash your hands often, but especially before and after touching your genital area or any urinary equipment.
- Wash your genital area with non-irritating soap, such as Dove or Tone. Rinse well with water and dry thoroughly.
- Wash your genital area after bowel movements and sexual activity.
- Avoid sitting on urine-soaked materials such as underwear, clothing, bed linen and wheelchair cushions.
- Wipe after bowel movements from front to back or away from the urethral opening.
- Wash all materials that come in contact with your genital area and buttocks with non-irritating soap and keep dry.
- Use the bladder emptying method that works best for you so that your bladder is always emptied thoroughly.

### 2. Kidney and Bladder Stones

Stones in the urinary system are usually the result of repeated infections and not drinking enough fluids. Kidney and bladder stones are gravel-like substances consisting of calcium, phosphates and other mineral salts. A small kidney stone may pass through the ureter,

causing extreme pain and possibly infection, especially if it becomes stuck. Bladder stones may cause increased symptoms of bladder infection, severe sweating or increased muscular spasms.

Some changes that may alert you to the presence of stones in your urinary system include:

- Tea- or cola-colored urine with blood or blood clots
- Passage of small gravel-like substances during urination
- Pain in the abdomen or lower back
- Increased bladder spasms
- Low or no urine output
- Recurring urinary tract infections
- Fever

Seek treatment from your doctor or go to the emergency room at once if any of the above occurs. A yearly X-ray of your kidneys is an effective way to check for kidney damage or kidney stones. A cystogram (bladder X-ray) can determine reflux or bladder stones.

### 3. Urine Retention

A high volume of residual (leftover) urine in the bladder can cause problems for either a reflex or non-reflex neurogenic bladder. These problems may include recurrent infections and could predispose you to bladder stones.

Signs and Symptoms of Urine Retention:

- Decreased amount of urine or no passing of urine from the bladder within a six- to 24-hour period
- Enlarged or hardened bladder (easily felt or seen) in the lower abdomen
- Abdominal pain (if you have sensation)
- Autonomic dysreflexia (usually in persons with a spinal cord injury above T6)

#### What Should You Do About Retention?

If you think you are retaining too much urine, do self-catheterization as soon as possible to prevent autonomic dysreflexia (see Chapter 5). If you are unable to self-catheterize, call your doctor at once or seek help in an emergency room.

### 4. Autonomic Dysreflexia

Autonomic dysreflexia is a potentially life-threatening abnormal response or nervous system reflex and should be considered an emergency (see Chapter 5). The most frequent cause is over-stretching the bladder. Therefore,

it's very important to empty the bladder often, monitor fluid intake and watch your residual urine amount.

### 5. Reflux of Urine

Reflux of urine occurs when urine is forced from the bladder back up through the ureters to the kidneys (see Figure 7.3). This may occur when the sphincter muscles are too tight, causing a large amount of residual urine volume. The urine left in the bladder is under high pressure, and this can result in serious damage to kidney function.

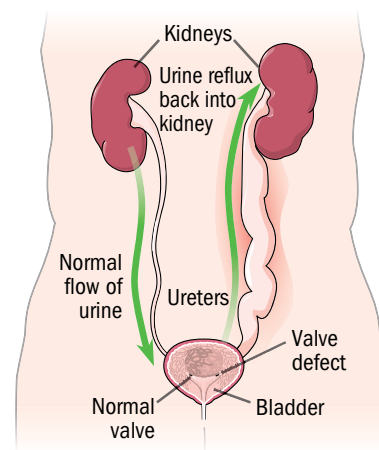

**Figure 7.3** Reflux of urine back into the kidneys.

### 6. Hydronephrosis

Hydronephrosis is an enlargement of the urine-collecting structure of the kidneys resulting from a backflow of urine to the kidneys. It can also be caused by a blockage in the ureters that lead from the kidneys to the bladder, or by kidney infection.

Periodic evaluation by your urologist or your rehabilitation physician is crucial to ensure that your kidneys and bladder are working correctly.

#### DIAGNOSTIC STUDIES

Your doctor may order one or more of the following diagnostic tests as part of your regular health maintenance program or to diagnose possible complications:

**KUB** (Kidney Ureter Bladder) is a single X-ray, without dye, of the kidneys, ureters and bladder to detect stones.

**IVP** (Intravenous pyelogram) includes multiple X-rays of the urinary tract following intravenous injection of dye.

**Renal scan** is a scan of the urinary tract following intravenous injection of a nuclear substance.

**Renal ultrasound** uses ultrasound waves to create images of the kidneys and sometimes the bladder. Although it gives somewhat less information than IVP, it is noninvasive.

**Cystogram** is a bladder X-ray following insertion of dye through a catheter in the bladder.

**Cystoscopy** is inspection of the bladder using an instrument passed through the urethra.

**Urethrogram** is an X-ray using dye to outline the anatomy of the urethra.

**Video Urodynamic Studies (VUDS)** is testing of the urinary tract functioning, including bladder capacity, bladder pressure and coordination of bladder contraction with sphincter relaxation.

### **CLEANING AND CARE OF YOUR BLADDER MANAGEMENT EQUIPMENT**

To maintain a healthy and bacteria-free urinary system, you need to care not only for yourself, but also for your bladder management equipment.

Clean your bladder management equipment thoroughly to remove urine or sediment that could contain bacteria and cause infection and odor.

#### **Reusable Intermittent Clean Catheterization Equipment**

Upon discharge from the hospital, you will use the clean catheterization technique. The following are instructions for cleaning your catheter:

Supplies:

- A basin or sink of warm water
- An antibacterial soap like Dial liquid soap
- Rubbing alcohol
- A 60-cc syringe
- A clean dry towel or paper towels
- A container or zip-lock bag in which to store your clean catheters

#### **Procedure:**

To begin, add the soap to the basin of warm water to make a soapy solution. Wash the catheters in the solution. Draw up some of the soapy solution into the syringe and then squirt this through the catheters to clean the inside of the tubing. Rinse under running water making sure to rinse the soap from both the inside and outside of the catheters.

Shake the catheters to remove water from the inside of the tubing and dry with the towel. Rinse out the syringe and use it to draw up some of the rubbing alcohol. Flush the inside of the catheter with the alcohol and shake to dry. The alcohol speeds drying, and bacteria cannot grow inside a clean dry catheter. Allow the catheters to dry thoroughly and then store in the container. A zip-lock bag, travel toothbrush holder, fanny pack or travel case is ideal for carrying the catheters and supplies with you.

**REMEMBER:** Never re-use a catheter without cleaning it and never use a catheter that is rough, stiff, worn, discolored or damaged in any way. You should have enough clean catheters on hand for a 24-hour period. This will enable you to clean and dry all of your catheters only once a day.

#### **Urinary Drainage Bags**

(Bedside and Leg Bags – Indwelling and/or Exterior)

1. Prepare two containers:
  - Washing solution:
    - A few drops of dishwashing detergent to 2 cups water
  - Rinsing solution:
    - 1 ounce (2 tablespoons) white vinegar to
    - 1 quart (4 cups) water
2. Obtain a clean 60-cc barrel-tip syringe, funnel, pastry (bulb) syringe or plastic squeeze bottle that has a pointed cap.
3. Pour ¼ cup of the detergent solution into the tubing and bag. (Please note: Be sure that the clamp on the tubing is open.)
4. Work the detergent solution back and forth. Be sure that the cleaning solution is poured in from the top so that it coats the entire inner surface of the tubing and drainage bag.
5. Drain the cleaning solution from the bottom outlet of the drainage bag.
6. To rinse, pour a syringe full (1/4 cup) of vinegar solution into the tubing and drainage bags.

7. Drain the vinegar solution from the bottom outlet of the drainage bag.
8. Hang the drainage bag in a clean place and allow it to dry, preferably in sunlight.
9. If the drainage bag is not used regularly, store in a clean towel or a paper or plastic bag until needed.

**Some Helpful Tips for Using Urinary Drainage Bags**

1. Urinary drainage bags may be obtained through the hospital supply or any medical supply company. Your case manager will assist you in obtaining your urological supplies. A physician's prescription may be required.
2. To reduce odor in your leg bag and bedside bag, put two aspirin tablets in the bag when in use.
3. Clean leg and bedside urinary drainage bags at least once a day.
4. Leg bags should be replaced every month (depending on the type and use).
5. A bedside bag should be replaced every one or two months, or when a leak develops.
6. Have several leg and bedside bags available so that one set can be cleaned and dried, ready for use.

**Reusable External Catheter**

Change your reusable external catheter daily or as necessary if leakage occurs. Bath time is often a good time to change it.

The following are procedures for cleaning your reusable external catheter:

1. Disconnect your bedside drainage bag or leg bag and cap tubing.
2. Gently remove old tape and external catheter. Inspect genitals for redness or skin breakdown.
3. Rinse the external catheter immediately with cold water.
4. Turn the catheter inside out.
5. Soak the catheter in baking soda solution (1 tablespoon to a quart of warm water) for 15 minutes.
6. Rinse again with plain water and allow it to dry overnight.

**(NOTE:** Do not place your external catheter in sunlight or near a hot radiator, as the heat may damage the rubber.)



**HIGHLIGHTS**

- The goal of your bowel program is for you to return as nearly as possible to your pre-injury bowel-emptying schedule.
- There are two common types of bowel function related to the level of injury: spastic/reflex anal sphincter or flaccid anal sphincter.
- S=Schedule a particular time of day for taking bowel medications, performing evacuations, eating, drinking and exercising.
- E=Exercise, increased or decreased, can cause changes in your bowel movements.
- L=Liquids, amount and type, can affect your bowel program.
- F=Fiber adds bulk to the diet and improves regularity of bowel movements.
- Factors regulating your bowel program include: pre-injury bowel habits, medications, emotional stress, psychological factors, positioning and timing.

**HOW THE BOWEL WORKS**

Eliminating the waste products of digestion is accomplished by emptying the bowel. The small intestine absorbs nutrients from the food you consume. Undigested food products move into the large intestine where water is removed, and stool is formed. Stool is stored in the large intestine until the wave-like action of the bowel moves it through the rectum and out of the body.

**WHAT HAPPENS TO THE BOWEL AFTER SPINAL CORD INJURY?**

Spinal cord injury may interrupt sensory signals from the bowel to the brain (feeling the urge to have a bowel movement). Therefore, messages do not get through to your brain to signal that your bowel needs to be emptied (see Figure 8.1). Your injury may also block signals from your brain to your sphincters or rectal muscles, resulting in the loss of voluntary bowel control.

Since you may not feel the urge to move your bowels, or have control of your sphincters, you may be prone to constipation, impaction or unplanned bowel movements. Therefore, it is necessary to start a program of emptying your bowels on a regular basis as soon as possible

**STAGES OF YOUR BOWEL PROGRAM**

The goal of your bowel program is to return as nearly as possible to your pre-injury bowel-emptying schedule. To help you reach that goal, it is important to understand the stages that your bowels go through after a spinal cord injury.

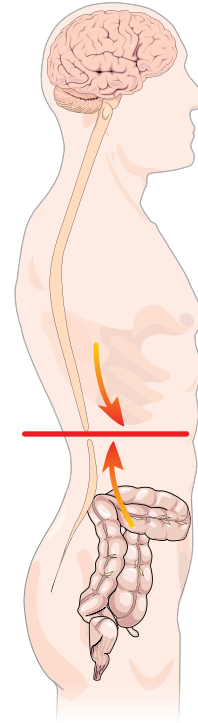

**Figure 8.1** Reflex Neurogenic Bowel. At the level of injury, messages to and from the bowel are blocked by injury to the spinal cord.

Immediately after a spinal cord injury, the bowels slow down or become completely inactive for a period of time due to spinal shock. You may also experience inconsistency in how your bowel empties. Even after the spinal shock period, you may not feel the urge to have a bowel movement or be able to control a bowel movement.

During and after spinal shock, you may experience the following:

- Decreased peristalsis (wave-like contractions) in the bowel muscles that normally produces a bowel movement. This slowdown in peristalsis may cause you to have nausea and gas.
- Decreased appetite
- Dehydration due to increased calcium output through the urine
- Constipation due to immobility and lack of physical activity

When you first come to the rehabilitation hospital, it may be necessary for you to take laxatives and/or enemas to rid your bowels of any accumulated stool. The next step is to begin increasing and balancing your food intake, and increasing your physical activity, all of which affect your bowel program. The focus is on decreasing involuntary stools (accidents between regularly scheduled bowel programs) and on regulating your bowels and learning the proper techniques. You must consider diet and fluid intake, timing, physical activity and exercise, positioning, adjustment of medications, digital stimulation and suppositories. At times you may still need to take laxatives and/or enemas to rid your bowels of any accumulated stool.

**TYPES OF BOWEL FUNCTION**

After spinal shock, there are two common types of bowel function related to the level of injury: spastic/reflex anal sphincter or flaccid anal sphincter. It is important that you know the type of bowel function you have so you can manage your bowel program effectively.

<b>Type</b>	<b>Level of Injury</b>	<b>Bowel Program</b>
Spastic or Reflex	Spinal Injury above T12/L1	Consistent habit and time. Begin with a program that occurs every day and decrease this frequency as directed by your physician. Use a suppository and digital stimulation to trigger reflex elimination. Consume high levels of fluids and fiber. Regulate stool consistency.
Flaccid or Non-reflex	Spinal injury below T12/L1	Consistent habit and time. A bowel program will need to occur every day unless your physician directs otherwise. Use a suppository and manual removal of the stool in the rectum as instructed by your physician and/or nurse. Regulate levels of fluids and fiber to develop a stool consistency that is firm but not too hard.

### HELPFUL HINTS IN CHOOSING AND SETTING UP A PROGRAM

The word **SELF** can remind you of the elements of a successful bowel control program:

S = Schedule

E = Exercise

L = Liquids

F = Fiber

#### S = Schedule

Schedule refers to the designated time of day for daily activities such as taking medications, performing evacuation, eating and drinking, and exercising. All of these activities must be scheduled so the bowel program can work effectively. Oral medications for the bowel must be taken at the proper time to ensure that they take effect at the time the suppository is due. For example, Senokot<sup>®</sup> (a laxative) should be taken approximately 6 to 8 hours before inserting the suppository.

Select a convenient time for your bowel program and maintain a consistent, daily schedule until you are free of bowel accidents. Once you are more comfortable with what works best for you, you may progress from a daily schedule to an every other day/night bowel program. If you develop constipation or have unscheduled bowel movements, return to a daily schedule until your bowel program stabilizes.

#### E = Exercise

Exercise refers to your normal daily level of activity. Any significant increase or decrease in your activity might cause changes in the movement of bowel contents. Long periods of time in bed can result in constipation and require adjustments in your usual daily routine.

#### L = Liquids

How much you drink is as important as what you drink. Liquids containing caffeine or alcohol, such as coffee, beer, tea or cola, generally will increase bowel activity. Prune juice or apricot nectar helps promote bowel regularity. Large amounts of any liquid may result in diarrhea, and too little liquid intake may result in constipation. Whenever possible, drink at least 2,400 cc (4 to 5 pints) of liquid, preferably water, a day to keep stools soft. Fever from any source may require extra fluids. Remember to keep your bladder program in mind when you regulate your fluid intake.

#### F = Fiber

Fiber adds bulk to the diet and improves regularity of bowel movements. You may want to track your diet for three days to determine which foods are constipating or stimulating.

Examples of foods high in fiber are:

#### Whole Grain Cereals/Breads

- bran
- Oats
- Oatmeal
- Wheat
- Rye
- Granola

#### Fruits

- Raisins
- Oranges
- Tangerines
- Plums
- Apples

#### Vegetables

- Lettuce
- Spinach
- Broccoli
- Squash
- Cauliflower

### FACTORS IN REGULATING YOUR BOWEL PROGRAM

**Pre-injury bowel habits.** Your bowel habits before injury, such as use of laxatives, frequency of bowel movements, usual time of emptying bowels, food habits, liquid intake and usual type of stool, all affect how your bowels will function after spinal cord injury. If possible, schedule your bowel program around the same time you had prior to your injury.

**Medications.** Stool softeners and bulk-forming laxatives such as Metamucil<sup>®</sup> can work with a high-fiber diet (see previous list of foods) to regulate your stool so that it is the desired softness. On the other hand, medications such as antibiotics, iron-containing substances and pain medications can also affect the consistency of your stool, often causing constipation. Be familiar with all medications you are taking and how they may affect your bowel program.

**Emotional stress.** Anxiety can affect your bowel program. For example, marital problems, financial problems, or a school exam may cause stress that, in turn, may cause changes in your bowel program.

**Psychological issues.** Try to ensure that you have privacy. Allow enough time for the suppository to work and for your bowel to empty completely. Relax and do not hurry.

**Positioning.** When possible, perform your bowel program sitting and leaning forward (if possible) on a commode or commode chair.

**Timing.** Set up a consistent time each day for your bowel program. If your personal habits (i.e., food and fluid intake and exercise) are regular, and you do your bowel program at a consistent time, you can expect to have a regular bowel program. Please note: A hot drink such as coffee, cocoa or warm prune juice stimulates peristalsis (the wave-like motions of the bowels).

It is possible to develop a regular bowel program that avoids accidents. Your team members will work with you and your caregiver to establish such a program that you'll continue at home. **Remember, a bowel program is simply a systematic way of emptying your bowel at a certain time at regular intervals while avoiding accidents in between scheduled programs.**

#### **CARRYING OUT A PROGRAM: BOWEL PROGRAM BASICS**

Your bowel program may include any of the following:

- Medications
- Digital stimulation
- Enemas
- Removing impactions manually

#### ◆ **Medications**

##### **Stool Softeners**

Softeners are taken to hold water in the stool, making it softer and easier to expel from the bowel. Softeners should be used when the stool is of hard consistency and when food or fluid intake is below normal. When physical activity and food or fluid intake are regulated and adequate, stool softeners may no longer be necessary.

Examples of Stool Softeners:

- Colace<sup>®</sup> or docusate sodium
- Surfak<sup>®</sup> or docusate calcium
- Dialose<sup>®</sup> or docusate potassium

##### **Laxatives**

Laxatives stimulate movement of the muscles of the bowel, helping the stool to move through the bowel. Your choice of laxative will depend upon your individual circumstances.

Oral laxatives are adjusted according to:

- How often the bowel is emptied
- How long it takes the bowel to empty after stimulation
- Amount of stool emptied

Examples of oral laxatives:

- Bisacodyl tabs
- Magnesium citrate
- Senokot<sup>®</sup>
- Castor Oil
- Milk of Magnesia
- Cascara
- Perdiem<sup>®</sup>

##### **Combination Stool Softeners and Laxatives**

Occasionally stool softeners and laxatives may be combined for convenience. Examples of combination stool softeners and laxatives:

- Doxidan<sup>®</sup>
- Dialose Plus<sup>®</sup>
- Senokot S<sup>®</sup>
- Correctol<sup>®</sup>

##### **Bulk-Forming Laxative Preparations**

If your diet is low in fiber, a bulk laxative may be right for you. Take bulk laxatives rather than the stool-softeners for a more effective bowel movement. Bulk-forming laxatives mix with water in your intestines, then swell and form a soft bulky stool. The bulkiness of the stool stimulates the bowel wall to contract, allowing you to have a bowel movement. Metamucil is an example of a bulk-forming laxative.

### Suppositories

Suppositories are used with softeners and/or laxatives to stimulate evacuation from the lower bowel and rectum. They are given rectally and work by contact with the wall of the rectum.

There are four types of suppositories that may be used in a bowel program.

- Bisacodyl, Dulcolax<sup>®</sup>, Senokot and Magic Bullet<sup>®</sup> are stimulants and work well on persons with high-level injuries.
- Glycerin is a lubricant-type of suppository.
- Ceo-Two<sup>®</sup> works by releasing carbon dioxide gas. The pressure of this gas against the wall of the rectum stimulates muscle contractions resulting in evacuation. Ceo-Two is most effectively used by persons with a low level of injury.
- Enemeez<sup>®</sup> is a mini-enema. It comes in a plastic container with 5 cc (a teaspoon) of liquid made of mild soap, docusate and glycerine. The long, protruding end must be punctured with a sharp object or clipped with scissors. The open end is placed into the rectum and the liquid is squeezed into the rectum.

Suppositories are best if stored at room temperature. Refrigeration delays the action.

### Suppository Insertion

You are the person responsible for carrying out your program, whether you perform it yourself or give instructions to someone else. Your team members will evaluate your capabilities to perform your bowel program independently and your OT will make recommendations for special devices.

Insertion Procedure:

- Before unwrapping, place the suppository under running tap water for 5 to 10 seconds to soften it and activate the process.
- Unwrap the suppository. Do NOT use lubricating jelly with suppositories since this will decrease their effectiveness.
- Put on a glove.
- Sit on the bedside commode chair or toilet or, if you are in bed, lie on your **left side** with padding materials (Chux<sup>®</sup>) under the buttocks area.
- If you are inserting the suppository yourself, simply follow the body “landmarks” to guide the loaded

suppository inserter or suppository into the rectum. Feel the gluteal fold, then follow it downward to the rectum.

- If you feel hard stool, which prevents proper insertion of the suppository, gently remove stool. The suppository is not effective if it is inserted into a fecal stool mass.
- Insert the suppository, pointed end first, high into the rectum beyond the external and internal sphincter.
- Push the suppository against the side of the rectal wall.
- If the suppository insertion is done in bed, transfer to commode chair or toilet 20 to 30 minutes later, if possible, for bowel evacuation. Sitting on the commode chair will help to push all the stool out of the rectum.
- To prevent accidents, perform the digital stimulation procedure after 15 minutes, whether or not you have had results from the suppository. This will ensure that your bowel is completely emptied of stool.

### ◆ Digital Stimulation

Digital stimulation is a technique used to induce reflex contraction of the colon and relaxation of the anal sphincter muscle.

- Digital stimulation can be performed while sitting or while lying in bed. If in you are in bed, remain on your left side.
- Apply glove and apply lubricating jelly. Important: a dry glove or long fingernails may injure the rectal tissues.
- Insert finger into the rectum about 1½ to 2½ inches.
- Move the finger in a circular motion around the rectal wall. Continue moving the finger firmly in a circular motion around the rectal wall for one to three minutes, at the rate of approximately one second per turn. The internal sphincter should seem to be loosening and you may feel the stool oozing down your finger. Repeat stimulation every 15 minutes up to three times, even if the results occur before you have completed all stimulations. This procedure will ensure complete emptying of the bowel.

Be sure to wash your skin with mild soap and water following your bowel movement. Stool can cause skin to break down.

Over a period of time, you may discover that emptying can be started with the use of digital stimulation alone. At this point, you may omit the suppository and only use digital stimulation. However, resume use of a suppository and digital stimulation on the third day if you have had poor results on two consecutive days.



**Abdominal Massage**

It may be helpful to massage the abdomen from right to left in a circular downward (clockwise) motion that follows the direction of peristalsis in the colon. Do this while you are sitting on a commode or commode chair, or in bed, 20 minutes after using a stimulant.

**◆ Enemas**

Enemas are used to flush out the contents of the lower intestines. They should never, under any circumstances, be considered the total solution to emptying the bowel. One should use an enema only if the bowel program is ineffective despite the use of suppositories and digital stimulation. If the bowel is felt to be full, the abdomen is hard and distended, and no emptying has occurred in three days, then the enema may be the recommended option in conjunction with an oral laxative taken about 12 hours before the enema.

Before you give yourself an enema, you should know some general information about the rectum and bowel. The rectum and bowel are lined with a mucous membrane that is sensitive and can be injured with a rough object or water that is too hot. Some germs (bacteria) contained in the bowel can cause infection of the skin or urinary tract.

**Females: Clean well after the enema and always wipe away from the urinary opening and toward the rectum.**

The enema solution (or type of fluid) determines how the bowel is stimulated to empty. There are several types of enema solutions, and they include the following:

**Saline, mineral oil and glycerin enemas (SMOG)**

The SMOG enema is used for the relief of constipation and for bowel cleansing. It is a combination of saline (300 cc), mineral oil (300 cc) and glycerin (300 cc). You may mix this formula at home or have it mixed by a pharmacist. This enema causes a combined effect of local irritation of the colon, increased gastric motility, lubrication and stool softening, and retention of water in the colon. Regular use of this type of enema is not recommended.

**Tap-water enema\*****(see below) and normal saline enemas**

These enemas create pressure on the wall of the rectum. The increased volume within the rectum causes a bowel movement.

**Instructions for Tap Water Enema**

- Prepare the solution:
    - 500 cc (two 8-ounce glasses) of warm (not hot) tap water (does not need to be sterile water). Lubricate the tip of tubing with water-soluble jelly. Use gloves to prevent contamination.
  - If in bed:
    - Lie on your left side so that the lower colon and rectum can collect the fluid. Follow the body “landmarks” to guide the enema tubing into the rectum. Feel the gluteal fold, then move downward to the rectum. Women should ensure that the tubing is not in the vaginal opening. Hold the container of solution about 18 to 24 inches above the rectum. The higher the solution is held, the greater the pressure, or the force of flow into the colon.
  - If sitting on a commode chair:
    - Tilt forward, then reach behind you and insert the tubing (as explained above). You may need support, depending on your balance and ability to manage yourself. When sitting on a commode, do not raise the solution container higher than your waist. If you have no results, try again and hold the container slightly higher.
  - Another technique often used is the “slush” enema. It aids in loosening hard stool and removing gas from the lower intestinal tract. Simply allow the enema solution to flow into the rectum until the solution returns from the rectum. Then immediately lower the enema container approximately 18 to 24 inches below the rectum to allow the solution to drain back into the enema container. Repeat this technique approximately four to five times. You may see small pieces of fecal material return in the solution or the solution may become stool-colored in the container. You may need to stop the flow of solution to check the opening end of the tube to ensure it is not plugged by stool and then continue with the enema. This back and forth action will aid in softening and dislodging stool in the lower colon.
  - If your sphincter is flaccid, you may be able to use a colostomy irrigation kit to give the enema. The stoma cone prevents the fluid from running back out through the anus.
- NOTE: If you have no results, repeat the procedure but never use an enema more than three consecutive times.*

**Milk and Molasses Enema**

This enema softens hard stool and acts as a lubricant to soften and facilitate passage of hard stool. It consists of 10 ounces of molasses and 2 pints of milk. This solution may be mixed at home.

**◆ Removing Impactions Manually****Items Required:**

1. Gloves
2. Water-soluble lubricant  
(K-Y Jelly<sup>®</sup>, Surgilube<sup>®</sup>, Lubrifax<sup>®</sup>)
3. Padding materials (Chux) if in bed
4. Soap, water, washcloth and towel

**Procedure:**

- Lie on your left side with padding in place under buttocks or sit on commode or toilet.
- Put on glove.
- Lubricate index finger.
- Insert index finger slowly into rectum (using “landmarks” discussed in digital stimulation).
- Remove hardened stool gently and place on padding (Chux).
- Wash buttocks and surrounding area. Dry skin well.
- Dispose of stool, padding and other soiled material. Remove gloves. Wash your hands.

**CAUTION:** This procedure must be done gently or the wall of bowel may be injured. If the stool is felt higher up in the intestine, use an enema to soften and help expel it.

Manual removal of stool should not be confused with digital stimulation. It should only be used as a starting point for a bowel program or as an absolute last resort. It should never become a regular part of a bowel program.

**PROBLEMS AFFECTING YOUR BOWEL PROGRAM**

Problems you may encounter with your bowel program include:

- Involuntary bowel movements
- Constipation
- Diarrhea
- Hemorrhoids
- Rectal fissures
- Autonomic dysreflexia

**Involuntary Bowel Movement**

Until you have an established bowel program, it is not uncommon to have involuntary bowel movements. If this is a problem for you, take a look at your eating and fluid intake habits. Be sure you are eating a well-balanced diet that includes fiber (see Page 37). If the problem persists, evaluate your entire bowel program, including digital stimulation. You may need to increase the frequency of your planned bowel movements.

**Constipation**

Constipation can be caused by poor eating habits; certain medications, such as tranquilizers, pain medications, antacids, anticonvulsants, diuretics or iron preparations; low fluid intake; and not following a regular schedule. The type of constipation will depend on what is causing the problem.

If the bowel is not emptying, you may need to take a laxative at a regularly scheduled time before your bowel program or change to a different type of suppository.

If the stool is too hard, you may need to use a stool softener, increase your fluid intake and increase the amount of roughage in your diet.

Bananas, white rice, pastries, sugar and cheese may constipate you. Consumption of these foods should be reduced if constipation is a problem.

**Diarrhea**

Diarrhea can be caused by: impacted stool, poor eating habits and medications, such as some antibiotics. Before treating the diarrhea, always check for an impaction. Low impactions may be felt by using a finger cot and digital stimulation of the rectum. Higher impactions result in diarrhea containing mucus (shiny whitish strands) intermixed with stool. If an impaction is present, you may need to remove the stool, take a laxative, or take an enema. If an impaction is not present, take any over-the-counter antidiarrheal agent such as Kaopectate<sup>®</sup>, Pepto Bismol<sup>®</sup> or Imodium AD<sup>®</sup> and/or eat more binding foods such as bananas, rice and cheese. Other foods such as chocolate and spicy foods may act as an irritant and cause diarrhea. If the diarrhea

is caused by taking antibiotics, yogurt will replace the normal bacteria and decrease the diarrhea.

**Hemorrhoids and Rectal Fissures**

Hemorrhoids are caused by chronic constipation and prolonged straining during elimination. Rectal fissures (tears in the anal tissue) are caused by faulty bowel emptying such as constipation or extra large bowel movements. Following bowel management procedures that soften stool and reduce your need to strain excessively can prevent both of these conditions.

**Autonomic Dysreflexia**

Bowel distention follows bladder distention as the most frequent cause of dysreflexia, a serious condition that requires immediate attention (see Chapter 5).

**HIGHLIGHTS**

- Since a spinal cord injury greatly weakens the respiratory muscles, you are very vulnerable to contracting a respiratory infection. Any infection must be treated early and vigorously.
- Assist cough is a technique used to help remove secretions from the lungs by applying outside manual pressure to the chest wall as you attempt to cough.

**STRUCTURE AND FUNCTION OF THE RESPIRATORY SYSTEM**

**Nerve and Muscle Supply**

The level of your spinal cord injury determines which breathing muscles might be weakened (see Figure 9.1). The diaphragm, which is the major muscle used for taking in air, is located under the rib cage and separates your chest cavity from your abdominal cavity. The spinal cord sends signals from the C3, C4 and C5 levels to the diaphragm (see Figure 9.2) enabling you to breathe (see Figure 9.1). If your spinal cord injury is at the C5 spinal cord level or above, your diaphragm may not function properly. It may be necessary for you to use a mechanical ventilator to help you breathe.

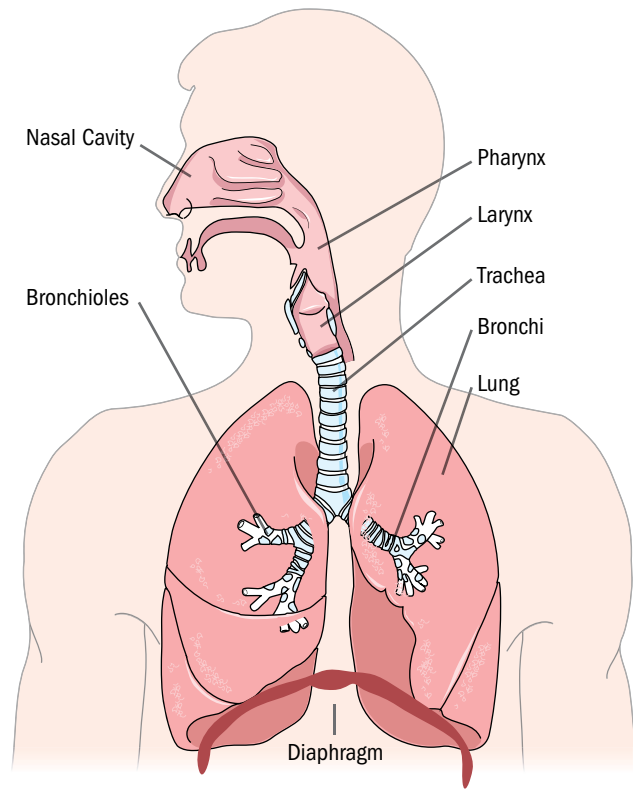

Figure 9.1 Respiratory system.

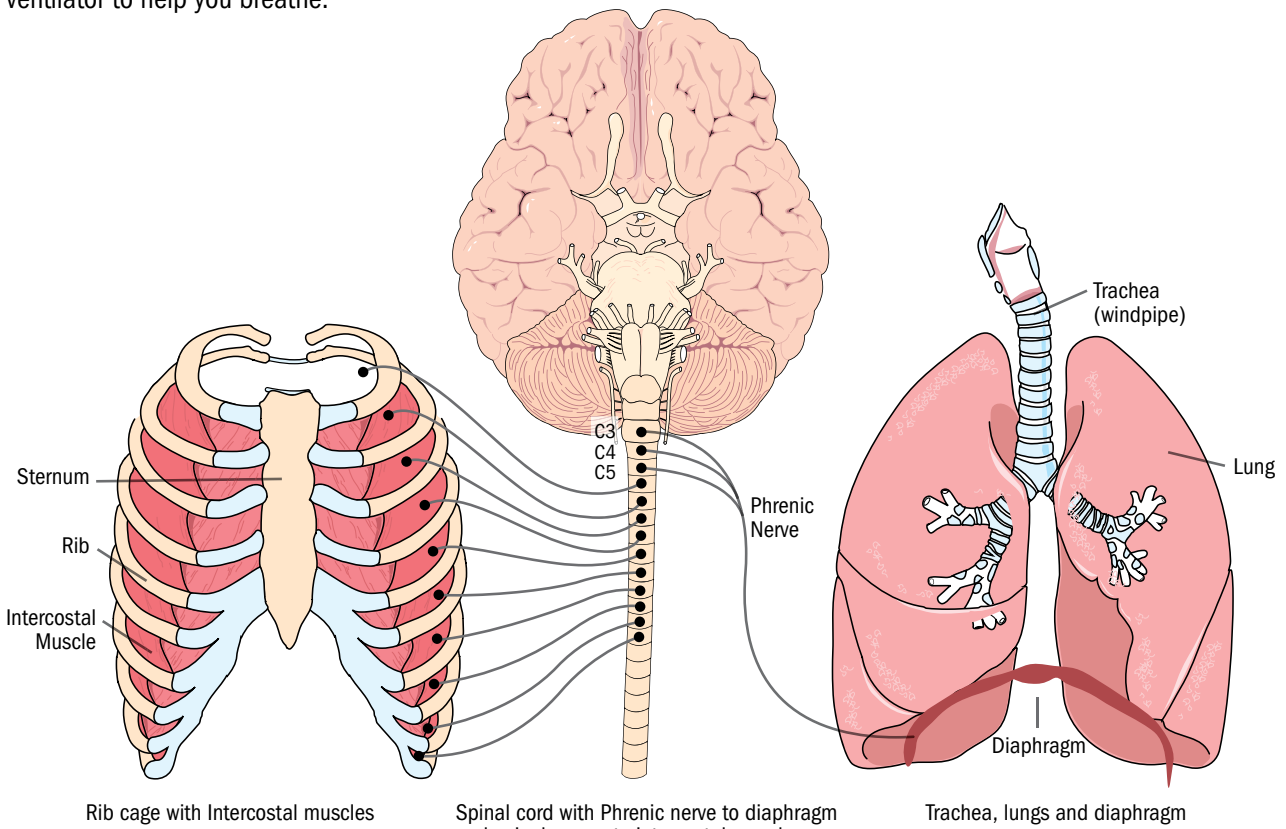

Figure 9.2 Structure of functioning respiratory system.

Your intercostal muscles are located between the ribs and help move the chest in and out when you breathe and cough (see Figure 9.2). The nerves that go to these muscles come from T1 to T11 spinal cord levels. With a spinal cord injury at T11 or higher, your ability to take a deep breath and to cough might be decreased because these muscles may not be working well.

The abdominal muscles function during any forced exhalation, such as a cough. The nerves that go to these muscles come from the spinal cord at levels T7 to L1. If your spinal cord injury is above L1, your ability to cough effectively may be decreased.

Another group of muscles, called accessory muscles, is located in the neck. They can also help you to breathe by assisting the diaphragm and adding more volume to the breath. These muscles receive signals from the spinal cord at the C2 to C7 levels.

### **Anatomy and Physiology**

Our bodies need oxygen to produce energy. Air contains about 21 percent oxygen. The basic function of the lungs is to utilize the oxygen that is in the air and to blow out carbon dioxide, the waste product of energy production.

All the air that you breathe in must be humidified (moistened) to prevent your lungs from drying out. Your nose and mouth humidify the air that you breathe. Your nose also filters out dust and pollution to prevent them from entering your lungs.

The lung is like an upside-down tree with grape-like clusters called alveoli at the ends of the branches. There are about 300 million alveoli in your lungs. This is where oxygen is absorbed into the bloodstream and carbon dioxide passes from the blood to the lungs to be exhaled. After the oxygen has been absorbed, it travels through the body in the arteries. The cells then use the oxygen to produce energy.

Air is drawn into the lungs as the diaphragm contracts. When the diaphragm relaxes, the air is pushed out of the lungs. Posture and position of the diaphragm can affect your ability to breathe.

### **Protective Mechanisms**

Certain natural mechanisms (such as sneezing and coughing) keep foreign bodies (harmful outside substances) from entering the lungs. One protection is the nose, which filters out large particles. When a large particle irritates your nose, you sneeze, forcing the irritant out of your nose.

If an irritant gets past your nose and makes it to your airway, you will cough to remove the irritant. When irritants such as smoke and pollution are introduced into your lungs, more mucus is produced. This mucus helps to remove the irritants and infectious materials.

Your spinal cord injury may decrease your ability to moisturize air or remove irritants in your body. For example, your respiratory muscles may be weakened, resulting in an inefficient cough, making you more susceptible to infections.

Or, if you have a tracheostomy, the air you breathe bypasses your nose and mouth. Since your nose and mouth humidify all the air that you breathe, this air must be artificially humidified. This can be accomplished by using a device that provides an aerosol mist to the trachea. Another device called an “artificial nose” may also be used to provide humidity. This device uses a specially treated paper that traps moisture from the exhaled breath and adds it to the inhaled air.

### **AFTER SPINAL CORD INJURY**

With a spinal cord injury at the L1 level or higher, the abdominal muscles may be weakened, so the ability to sit upright with good posture may be decreased. A slumped, slouched posture might result in shorter, shallow breaths because the diaphragm doesn't move as effectively as it did prior to your injury.

Your abdominal binder can provide support, which will assist with posture and help maintain the diaphragm in a better position for breathing efficiently. Appropriate wheelchair positioning is also an important component of maintaining optimal upright posture for efficient breathing.



### MECHANICAL VENTILATOR

If you require a mechanical ventilator to help you breathe, the ventilator will be adjusted to meet your individual breathing requirements. The doctor will know how much air you need from the ventilator and will prescribe the ventilator settings.

The ventilator will be set to:

- Pump the right amount of air into your lungs with each breath (called tidal volume).
- Give you the right number of breaths each minute (called the breathing rate).
- Move the air into your lungs as fast or as slowly as you need it.
- Provide all of your breaths or assist you when you start to take a breath on your own.
- Provide supplemental oxygen as required.

### Ventilator Alarms

Every ventilator has alarms to alert others when the ventilator is disconnected, malfunctioning or just unable to provide adequate breathing for you.

**Low-Pressure Alarm.** The low-pressure alarm control will be activated when you are not receiving enough air. The alarm is important so that conditions causing low pressure can be found and corrected. The low-pressure alarm includes a sound and a light, which will be demonstrated for you by your respiratory care practitioner. Low-pressure situations may occur with the following:

1. A loose connection or disconnection of the ventilator tubing
2. A leak around your tracheostomy tube or leak from the tubing
3. A leak in your exhalation valve or tubing

**High-Pressure Alarm.** The high-pressure alarm control is activated when ventilator air is blocked from entering your lungs. This is important so that any conditions causing the peak pressure to go up can be corrected. The high-pressure alarm includes a sound and a light (both will be demonstrated for you). High-pressure situations may occur with the following:

1. Your airway needs suctioning or you are coughing.
2. The ventilator tubing has kinked.
3. Your airway is constricted or in spasm. You may need a bronchodilator drug to help open your airway.

The respiratory care practitioner will teach you how to use the ventilator properly and assist you in understanding ventilator alarms and ventilator settings.

**Saturation Alarm.** While on the ventilator your oxygen may be monitored by an alarm device connected to one of your fingers or toes.

### THE TRACHEOSTOMY TUBE

The purpose of the tracheostomy tube is to provide an open airway for breathing and to allow secretions to be removed from the lungs. Secretions are removed by tracheal suctioning or assist coughing.

Inserted into the windpipe (trachea) the tracheostomy tube bypasses your upper airway (your nose, mouth and vocal cords). The tracheostomy tube is connected to an inflation valve and a cuff or balloon, which surrounds the trach tube. It provides a seal against the tracheal wall when inflated. If you're unable to swallow or expel the secretions in your throat, the inflated cuff (balloon) will prevent secretions or food from entering into your lungs.

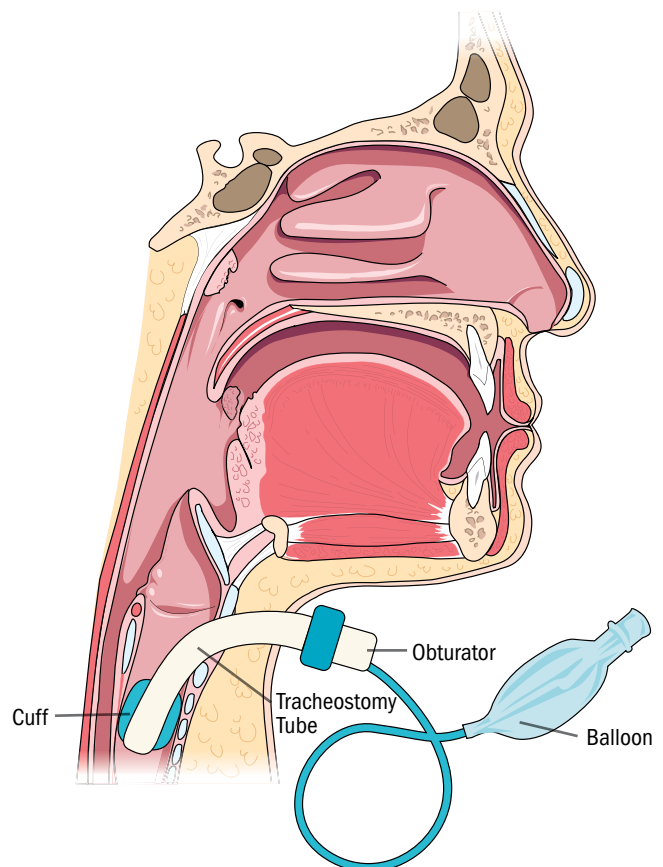

**Figure 9.3** Tracheostomy tube.

The cuff is inflated with air through the inflation valve by depressing the syringe attached to it. When the cuff is fully inflated you will not be able to speak. You will breathe through the tracheostomy tube which bypasses your nose, mouth and vocal cords. Once you are able to pass a swallowing test, the cuff may be deflated, allowing you to speak and swallow (see Figure 9.3).

If you are discharged home with a trach, you and your caregiver will be taught care of the trach and trach site.

### AVOIDING RESPIRATORY PROBLEMS

- Take care of yourself and stay healthy.
- Avoid excess fatigue.
- Avoid people with colds or the flu.
- Wash your hands to avoid picking up bacteria that cause infections. Anyone working with you should also wash his or her hands before and after providing care.
- Turn frequently while in bed. Turning allows different parts of your lungs to stretch and drain secretions. If you develop a respiratory infection, increase your turns to every two hours. This prevents the pooling of secretions in one part of the lung where a serious infection may develop.
- Do not smoke and avoid second-hand smoke.

#### Smoking and Its Effects on SCI

- Increased risk of developing lung cancer, emphysema and heart disease.
- Further reduces your lung capability already affected by your SCI.
- Increased risk for bladder cancer.
- Increased risk for developing pneumonia.
- Increased risk of pressure sores due to decreased circulation.
- Decreased ability to heal following surgery or injury.
- Increased risk of developing peripheral vascular disease, which can lead to amputation.
- Smoking contributes to periodontal (gum) disease.
- Male smokers have a lower sperm count, which is also affected by your SCI.
- Female smokers may have more trouble getting pregnant and also have a higher rate of miscarriage.
- Second-hand smoke puts people around you at risk.
- Smoking is an expensive habit, typically costing more than \$1,000 per year.

### COMPLICATIONS

#### Lack of Oxygen

Some signs and symptoms of lack of oxygen:

1. Increased heart rate.
2. Shortness of breath and working harder to breathe.
3. Restlessness and discomfort.
4. Bluish-gray fingernails or lips.

#### Infections

Since a spinal cord injury greatly weakens the respiratory muscles, you're very vulnerable to contacting a respiratory infection. Any infection must be treated early and vigorously. Some signs and symptoms of a respiratory infection are:

1. Productive cough requiring frequent suctioning. Also, an increased amount of sputum or change in the color of the sputum to yellow or green.
2. Fever of over 101 degrees Fahrenheit.
3. Heaviness in your chest.
4. Shortness of breath or difficulty breathing.

An infection may decrease your oxygen supply, so you should also look for the symptoms of lack of oxygen in the body (see previous section, "Lack of Oxygen").

### TREATMENTS

#### The Pflex® Trainer

The Pflex Trainer is a device used to train the muscles of inspiration (breathing in). This device can be easily used at home after your discharge from the hospital. The device provides resistance, which is controlled by a dial, through various-sized holes in the device. Air is drawn in through these holes as you inhale. The smaller the hole, the higher the resistance and difficulty of the exercise. The Pflex is issued by your physical therapist.



Figure 9.4 Pflex Trainer.

How to Use the Pflex Trainer:

1. Set the dial selector at the number recommended by your therapist.
2. Sit in a comfortable position; hold the Pflex level and place the mouthpiece in your mouth.
3. Breathe through your mouth and the Pflex only. (A nose clip is provided with the device if you have difficulty breathing only through your mouth.)
4. Inhale deeply and forcefully for two seconds. Exhale normally. Breathe slightly faster than you would normally.



**Figure 9.5** Pflex use.

Limit training to 10 to 15 minutes during the first week and gradually increase your training time as you are able. You should not feel exhausted during or after training using the Pflex. Proceed to the next level of resistance when you're able to do 30 minutes of training three times per week.

If you get very tired or dizzy during or following your training session, or if you have shortness of breath or a significant increase in heart rate, you should stop training. When symptoms have resolved, lower the resistance selection and continue training.

### Incentive Spirometry

Incentive spirometry (sustained maximal inspiration) is a breathing exercise used to strengthen the muscles you use to breathe in, and to prevent or correct the collapsing of portions of the lungs.

The proper way to use the incentive spirometer is as follows:

1. Exhale and empty your lungs.
2. Place mouth around the mouthpiece.
3. Inhale slowly and deeply.
4. Hold for three seconds.
5. Exhale slowly.
6. Repeat eight to 10 times.



**Figure 9.6** Incentive Spirometer.

### Intermittent Positive Pressure Breathing (IPPB) Therapy

IPPB is a breathing treatment that delivers positive pressure and nebulized (spray) medications to the lungs. IPPB will expand your lungs and deliver medication deep in the bronchial tree.

The IPPB machine will continue to fill the lungs with positive pressure along with the nebulized medications until the preset pressure is met. At that point, exhalation occurs.

The correct way to take an IPPB treatment is as follows:

1. Place mouth around the mouthpiece.
2. Inhale slowly and deeply through the mouthpiece.

3. Let the machine fill your lungs until the preset pressure is met.
4. Pause for two to three seconds.
5. Exhale slowly.

Breathing too fast on an IPPB machine may cause you to hyperventilate and become dizzy.

### Nebulizer Treatments

A nebulizer sprays a fine, liquid mist of medication either through a mask or a mouthpiece. These medications are usually prescribed to loosen mucus in the lungs so that it can be more easily coughed out. It usually takes 15 to 20 minutes to complete a nebulizer treatment.

To give a nebulizer treatment:

1. Gather supplies needed, including:
  - Medication to be nebulized
  - Nebulizer set (nebulizer cup, mouthpiece or mask, tubing to connect to nebulizer machine)
2. Place the nebulizer on a flat surface (i.e., table or the floor).
3. Plug the unit into a wall outlet.
4. Connect the air tubing to the nebulizer machine.
5. Put the medication into the nebulizer cup and screw the cap on securely.
6. Connect the other end of the air tubing to the nebulizer cup.
7. Connect the mouthpiece or face mask to the nebulizer cup.
8. Turn the machine on.
9. Check to make sure a fine mist of medication is coming through the face mask or mouthpiece.
  - Mouthpiece: Make sure your lips are sealed around the mouthpiece.
  - Face mask: Place the mask over your mouth and nose.
10. Take slow, deep breaths until all the medication in the nebulizer cup is gone.
11. Turn the nebulizer off.

After each treatment:

1. Disconnect the nebulizer cup from the tubing.
2. Open the cup and wash all pieces in a mild dish soap and water. (Do not wash or rinse the tubing.)
3. Rinse all pieces.
4. Air dry on a clean towel.

Store the dried nebulizer cup and tubing in a plastic bag.

All respiratory treatments can be adapted for use with a tracheostomy.

### REMOVING SECRETIONS

Following spinal cord injury, excess mucus and secretions can accumulate in the lungs and become a problem for persons who are unable to cough and remove these secretions.

The three most common methods for removing secretions include:

1. Assist cough
2. Suctioning
3. Postural drainage

#### Assist cough

Assist cough is used to help remove secretions from the lungs by applying outside manual pressure to the chest wall as you attempt to cough. Below are descriptions of different assist cough techniques. **The technique that you and your caregiver will use will be specific to you and taught by your therapist.**

Although you may be able to learn to do the assist cough maneuver on yourself, you will usually get better results if you have someone helping you. The assist cough can be done in bed or in a wheelchair.

There are three phases to an assist cough:

1. Take a deep breath in.
2. Pause.
3. Give a hard cough with manual assistance.

#### Assist Cough While Lying on Your Back

The person assisting you stands at your side, and while facing you places his hands in one of these three positions:

1. Hands on either side of your chest below the rib cage with the heels of the hands positioned in, toward the center of the stomach, and the fingers pointing outward (see Figure 9.7).

Take a deep breath and, at the count of three, cough.

The person assisting you pulls their hands in and down toward your belly button at the instant you are coughing. This helps squeeze the rib cage together to create a more forceful effective cough.



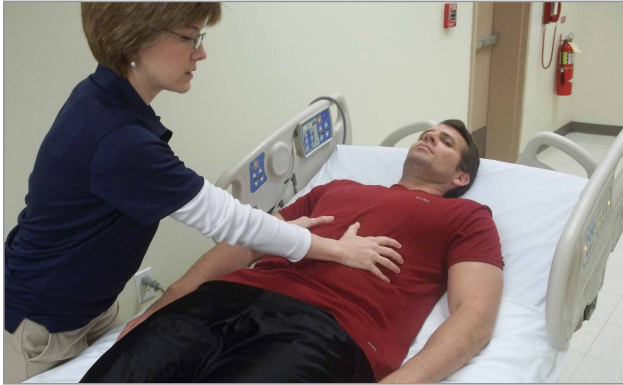

**Figure 9.7**

OR

2. The heel of one hand on your abdomen below the ribs above the belly button (see Figure 9.8).

**PRECAUTION:** Avoid applying any pressure to the lower tip of the breastbone.

Take a deep breath and, at the count of three, cough. The person assisting you pushes in and up at the instant you are coughing. This helps to push the diaphragm up to create a more forceful and effective cough.



**Figure 9.8**

OR

3. A forearm is placed across the chest, while the other forearm is placed slightly above the belly button (see Figure 9.9).

Take a deep breath and, at the count of three, cough. The person assisting you pushes both forearms in and toward the middle at the instant you are coughing.

Some people may perform their assisted cough while lying on their back (see Figure 9.10).



**Figure 9.9**

- 1) Create a fist with each hand and lace slightly above the belly button. Take a deep breath and, at the count of three, cough. Pull in and up at the instant you are coughing. This helps to push the diaphragm up to create a more forceful and effective cough.



**Figure 9.10**

**Assist Cough While Sitting**

The person assisting you positions himself in front of you and uses one of the above hand placements (see Figure 9.11a and 9.11b). Remember to lock the wheelchair and, if possible, place the wheelchair back against a wall or solid support.

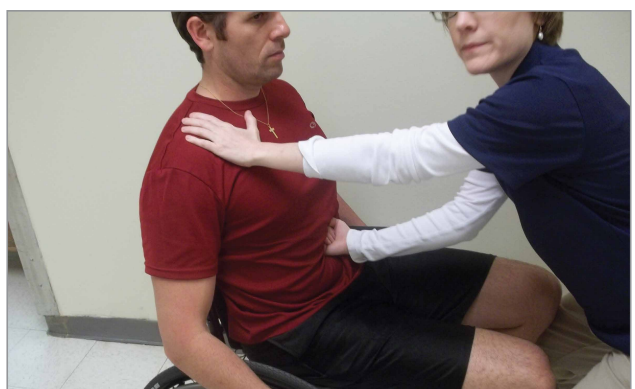

**Figure 9.11a**

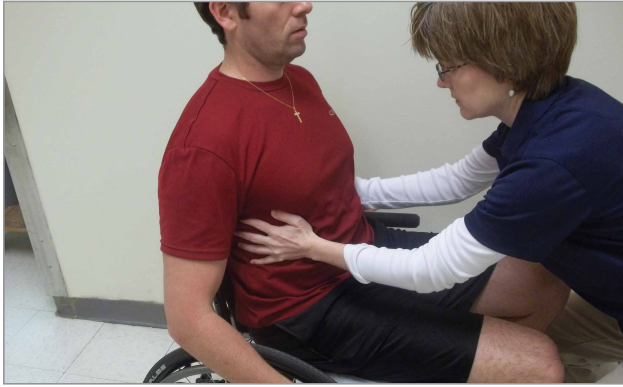

**Figure 9.11b**

If you wear an abdominal binder or corset, leave it in place when performing an assist cough, as it will help to create a more effective cough.

**If you are having poor results, make sure that:**

- The person assisting you pushes at the exact moment you attempt to cough.
- The person assisting is applying enough pressure and is not using quick, jerky motions.
- The abdominal binder is not too loose. The abdominal binder helps to support the stomach muscles. If you have any questions about the proper use and position of the abdominal binder, you should consult your nurse before leaving the hospital.

Your physical therapist and respiratory care practitioner will review these assist cough techniques with you and those who will be caring for you.

**IMPORTANT:** There are alternative methods for performing the assist cough technique if you are pregnant, have a feeding tube or have a blood clot filter placed. If you have acid reflux, it may worsen following a cough assist.

**Suctioning**

Suctioning is a safe, easy and inexpensive way to clear the airway of mucus, although assist cough is preferred.

Equipment needed:

1. Suction machine
2. Suction tubing
3. Gloves
4. Suction catheter
5. Ambu bag

You will receive specific training in suctioning from your respiratory care practitioner and nurse.

**Postural Drainage and Chest Percussion**

Postural drainage uses various body positions and gravity to drain and remove secretions from specific segments of the lungs. Since secretions tend to pool in the lower lobes of the lungs, your respiratory care practitioner may position you in the Trendelenburg or “head down” position. This position helps secretions drain toward the larger airways, where they can be coughed up (with assistance) or suctioned. See Figure 9.12.

Your respiratory care practitioner may also use chest percussion (clapping cupped hands rhythmically on the chest wall) to further aid in loosening secretions.



**Figure 9.12**



**HIGHLIGHTS**

- A balanced diet is the key to good health by meeting your body's nutritional needs. These needs may change over time, depending on your activity level and your general state of health. Choosing the diet that's right for you will help prevent nutrition-related complications.
- **Proper fluid intake is necessary for the removal of waste products from your body and regulation of your bowel program, temperature and blood pressure. It also helps heal wounds and prevent bladder infections.** Good sources of fluid include juice and milk, but the best source of fluid is water itself.
- **Adequate fiber intake from foods aids in your bowel program.** It's recommended that all individuals consume 25 to 35 grams of fiber every day. The best sources of fiber are fresh fruits, fresh vegetables, whole grains and legumes (beans). It is also important to increase fiber gradually in your diet to prevent constipation.
- Eating foods high in protein is very important for anyone who has a spinal cord injury. Protein builds muscles and keeps body organs healthy. **Protein also helps heal pressure sores if they develop, and helps the body fight infection.** The best sources of protein are eggs, meats, poultry, fish, milk, cheese, nuts, peanut butter and dried beans.
- Aim for and maintain a proper weight. Being underweight puts you at risk for developing pressure ulcers, makes it more difficult for your body to heal from an injury, and will make it more difficult to fight infections. On the other hand, being overweight will make your transfers more difficult, and put you at high risk for heart disease and pressure ulcers.

**A BALANCED DIET**

A balanced diet keeps you healthy by meeting your body's energy needs and by building and repairing body tissues such as skin. Good nutrition depends on choosing the right foods in the right amounts.

Everyone has different dietary needs. Being aware of your needs will help you choose the diet that is right for you. Your needs will change from time to time, based on your activity level and your general state of health. For example, if you are sick and have a fever, your calorie and fluid needs are higher. Try to eat smaller meals four to six times per day, choosing the right foods.

**FOOD GROUPS**

Different foods do different things to keep you healthy. Some foods supply energy, some build bones and muscles, and some help you control your bowel and bladder. The information below will give you a general idea of how many servings per day of food from each group to include in your diet.

The number of servings you need from each food group will vary when your health needs change. When this happens, your dietitian, nurse or doctor will work with you to plan a diet that's right for you.

**Protein**

Eating foods high in protein is very important for anyone who has a spinal cord injury. **Protein helps to keep skin healthy, helps heal pressure sores if they develop and helps the body fight infection.** Protein also builds muscle and keeps body organs healthy. For all these reasons, you need adequate protein in your diet. Some examples of protein foods are:

- Milk and cheese
- Peanut butter
- Meat, poultry and fish
- Eggs
- Dried beans
- Nuts

**Carbohydrates**

Carbohydrates are your main source of energy. Some of the foods rich in carbohydrates are also high in fiber. Fiber plays an important role in your bowel program. Some examples of these foods are:

- Whole grain breads
- Brown rice
- Bran cereals
- Potatoes with skins
- Fresh fruit
- Fresh vegetables

## Fats

Fat is in many of the foods we eat. Although some fat is a necessary part of any diet, you should avoid foods that are high in fat, especially saturated fat and trans fat. Fat insulates your body and is a backup energy source. Try to use low-fat items because excess fat and calories in your diet will cause you to become overweight. Some examples of fatty foods and their alternatives are:

High Fat	Low Fat
• Fried foods	Baked, broiled or grilled foods
• Ice cream	Light ice cream or sherbet
• Fatty meats	Lean meats with fat removed
• Cheese	2% or fat-free cheese
• Oils and butter	Canola or olive oil and margarine
• Whole milk	Skim or low-fat milk

## Fluids

Fluids are an important part of your diet. They help prevent bladder infections; remove waste products from your body; regulate your bowel program, temperature and blood pressure; and even help heal wounds. **Remember that some fluids, like alcoholic drinks (beer and wine) as well as caffeinated drinks (coffee, tea, cola), can dehydrate you and should be avoided.** Be sure to consume at least 64 ounces (8 cups) of fluid per day unless instructed by your doctor to limit your fluid intake. You will need to learn to monitor how much fluid you take in. Some examples of fluids are:

- Water
- Juice
- Milk
- Jello
- Soup
- Fruit
- Ice cream or sherbet

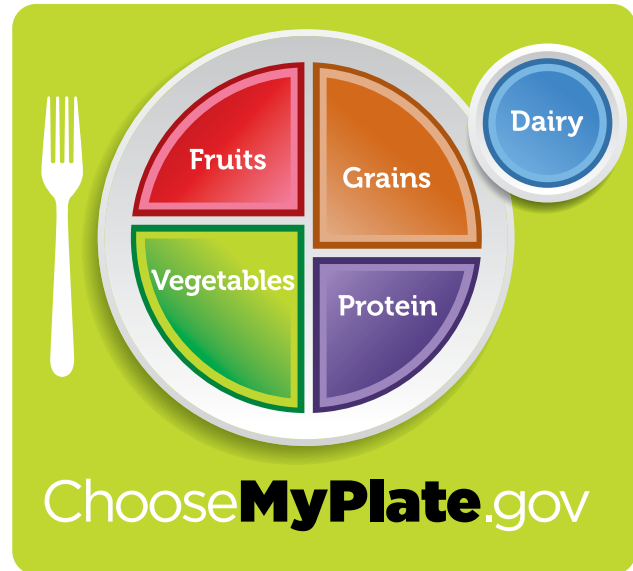

**Figure 10.1** Food Pyramid.

For Vegetarian Diet Pyramid for meal planning purposes see: [www.vrg.org/nutrition.adapyramid.htm](http://www.vrg.org/nutrition.adapyramid.htm) offered by the American Dietetic Association.

## NUTRITIONAL PROBLEMS

### Weight

You need to keep your weight steady. You may have lost weight after your spinal cord injury. If you were average or underweight before your injury, your doctor may want you to gain this weight back. He or she may encourage you to eat extra foods or smaller, more frequent meals (four to six times per day) to help you regain the weight you lost. Being underweight puts you at risk for developing pressure ulcers. You may have a harder time fighting infections, like colds or flu. It will take longer for your body to heal if you have any type of injury, like a fractured leg or arm.

On the other hand, being overweight makes your transfers more difficult and also puts you at risk for pressure ulcers. It makes it harder for you to carry out your daily living activities on your own. Excess weight strains your whole system and puts you at risk for heart disease and stroke.

By choosing a variety of foods each day, in the right amounts, you will be able to meet your body's needs and maintain your weight.

**Vomiting and Diarrhea**

You may sometimes throw up or get diarrhea. These can become major problems if they go on too long because of the fluid lost. Let your doctor know if the problem lasts more than 48 hours. While you're sick, your doctor may want you to follow a liquid diet. Here are some suggestions to help you do that:

- Drink clear liquids, such as broth, clear juices and water.
- Eat lighter foods. Avoid greasy foods, high-fiber foods and foods high in sugar. Jello, popsicles, warm tea and toast are examples of lighter foods.
- Eat small, frequent meals (four to six times per day).
- Get plenty of rest.
- Sip on cool, clear liquids between meals.
- Avoid hot or spicy foods. Try eating bland foods that are cool or room temperature.

**Bowel Problems (See Chapter 8)**

Your diet can affect your bowel program. If you do not eat enough fiber, you may become constipated. To take care of this problem, you may need to adjust your diet as well as your bowel program. Some changes you can make to your diet are:

- Drink warm prune juice. Prune juice helps your bowels to work naturally.
- Include plenty of high fiber foods, such as fresh fruit, vegetables and whole grains.
- Drink enough fluids (especially water) to avoid constipation.

**HIGHLIGHTS**

- Adequate range of motion (ROM) is necessary for good posture and performance of activities of daily living and functional mobility.
- Poor posture can lead to a variety of medical complications including skin breakdown, pain and inadequate breathing.
- Contractures are joint tightness that can result in permanent limitation. They result from lack of ROM.
- Increased spasticity can lead to skin breakdown and contractures, but can also be useful in some instances for functional activities.
- The cause of heterotopic ossification (HO) is unknown and may occur in some people with SCI. Signs and symptoms of HO include swelling, redness, limited ROM, limited ability to do daily activities and increased warmth in the affected area.
- Proper positioning in bed is essential for skin protection and maintenance of ROM.
- All of these key issues (ROM, spasticity, posture, HO and positioning) are interdependent. Problems in one area will have an effect on the other areas and may significantly affect your body's mobility.

**EXERCISE**

The value of exercise is a popular topic in our modern culture. You'll probably benefit from an exercise program, especially if that program is designed to meet your individual needs. Your occupational therapist and physical therapist will work with you to:

- Design a program especially for you, and give you a written copy to take home.
- Give you or your caregiver instruction on how to carry out the program.
- Make recommendations for appropriate exercise equipment.

Some of the most important benefits of regular exercise are:

- Improvement in cardiovascular function depending on the level of injury
- Maintenance of or improvement in muscle strength
- Maintenance of or improvement in joint mobility and muscle flexibility

- Increased ease and stamina in performing functional activities

Exercise programs vary from person to person. Your program may include:

- Passive range of motion exercises to maintain or increase joint mobility and muscle flexibility. These are performed either independently or by a caregiver.
- Functional activities such as typing, pushing your wheelchair and walking. These serve as exercise when they are performed independently and regularly.
- Active or resistive exercises for strengthening specific muscles or muscle groups.
- Conditioning exercises for increasing your stamina for functional activities.
- Recreational activities can be a fun way to provide strengthening and conditioning, as well as fun.

When choosing an exercise activity in addition to the specific exercises recommended by therapists, consider these practical guidelines:

- Be sure your doctor has cleared you for the activity.
- Choose an activity that you enjoy so that you will continue doing it.
- Make the exercise program a part of your daily routine. Consistency is a key factor in getting results.
- When possible, vary the exercise program to avoid becoming bored with it.
- Listen to your body. If you exercise properly, you can expect to be fatigued and sore, but over-fatigue and pain are not beneficial.

You may find standing to be beneficial even if you will not be walking. Although there are many reported benefits from standing, the proven benefits include prevention of contractures, relief of pressure on the buttocks, improved tolerance of the upright position and increased self-esteem. Other reported benefits are stimulation of circulation, reduction in spasticity and facilitation of kidney function and bowel elimination. Consult your physician or therapist to see if a standing program is indicated for you.

There are several methods of standing you can discuss with your physical therapist. The equipment used for standing includes tilt tables, standing frames and standing braces.

**RANGE OF MOTION**

The extent of movement possible for each body joint is called “range of motion” (ROM). The more flexibility you have in your joints, the greater the ROM. Maintaining good ROM in your shoulders, elbows, wrists, fingers, hips, knees and ankles can benefit your daily living skills, mobility and the health of your skin. ROM can also decrease the effects of spasticity on your body and help prevent health problems. However, ROM does not strengthen your muscles.

Persons without a disability usually move their joints through a reasonable ROM in their everyday activities. If you have an SCI, you may not use your available ROM. If the joints are not used or moved, they will tighten. Prolonged tightness can lead to a permanent limitation called a contracture.

Tightness or contracture can lead to severe consequences that may affect many aspects of your daily life. These can include:

**Sitting and posture.** Tightness in your trunk, legs and arms can cause you to sit unevenly in your wheelchair. Prolonged sitting in a poor position can result in permanent muscle tightness, thereby causing uneven weight bearing, skin breakdown, breathing complications and pain.

**Activities of daily living.** Tightness in your muscles can make it difficult to feed yourself, bathe yourself, get dressed or have someone assist you with these activities. In addition, tightness in your trunk and legs may keep you from being a candidate for walking.

**Standing.** You may be unable to continue with a standing program if you have tightness in the musculature or joints of your legs or trunk.

If contracture does occur, treatment/management may include:

1. ROM to the joints on a routine basis. If you have severe spasticity, ROM exercises may have to be performed more often (two to three times each day) and other means of spasticity management may need to be considered.
2. Proper positioning in bed and wheelchair
3. Casting, splinting or braces

4. Standing
5. Surgical management, which may include tendon releases

You may be able to perform your own ROM exercises or you may require assistance. Your physical therapist and occupational therapist will help you determine your particular needs. If you're unable to perform the activities yourself, you can learn how to instruct others so that you can be in charge of this important activity at home.

If you have tetraplegia, you are likely to have tightness in your shoulders and elbows. A prolonged stretch, in addition to daily ROM exercises, is necessary to prevent contractures and pain. To attain a prolonged stretch while in bed, the *cruciate position*, *Figure 11.1*, is recommended. You can do this stretch independently or with assistance.

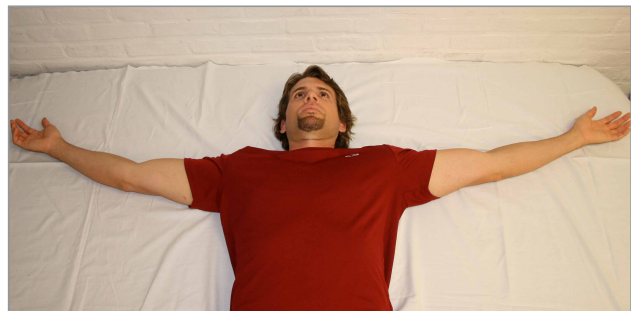

**Figure 11.1**

*Cruciate Position - arms away from body, elbows straight, palms up.*

**SELF RANGE OF MOTION LOWER EXTREMITY**

The following pictures demonstrate stretching exercises that some people are able to perform without assistance.

**Please consult your physician and therapist for specific recommendations and training.**

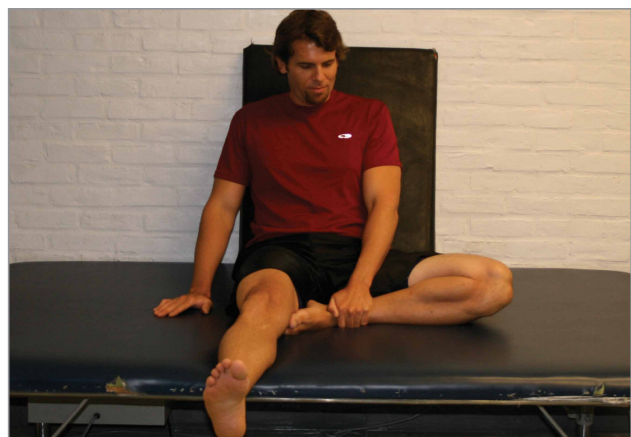

**Figure 11.2** *Single leg, frog leg.*





Figure 11.3 Double leg, frog leg stretch.



Figure 11.7 Heel cord stretch.



Figure 11.4 Single leg, knee to chest.



Figure 11.8  
Toe flexion.



Figure 11.9  
Toe extension.



Figure 11.5 Single leg, hamstring stretch.

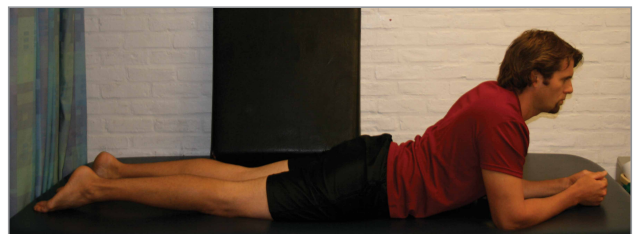

Figure 11.10 Back and hip extension.



Figure 11.6 Additional single leg, hamstring stretch.

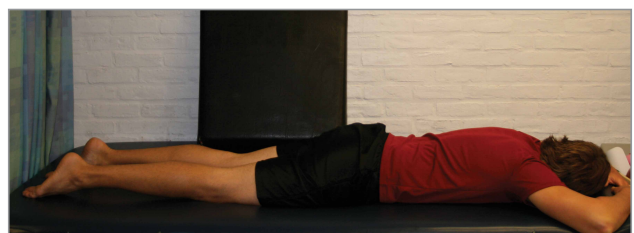

Figure 11.11 Flat on your stomach to stretch front of body.



**HELPER ASSIST RANGE OF MOTION LOWER EXTREMITY**

The following pictures demonstrate stretching exercises that a helper may assist some people with. **Please consult your physician and therapist for specific recommendations and training.**



**Figure 11.12**  
Hamstring stretch  
- Straight leg stretch.



**Figure 11.13**  
Hamstring stretch  
- Straight leg raise.



**Figure 11.17** Heel cord.



**Figure 11.18** Toe flexion.



**Figure 11.14** Knee to chest.



**Figure 11.19** Toe extension.



**Figure 11.15**  
Single leg - Frog leg.



**Figure 11.16**  
Hip Abduction



**Figure 11.20** Hip extension.

HELPER ASSIST RANGE OF MOTION UPPER EXTREMITY



**Figure 11.21**  
Shoulder flexion  
- Arm overhead.



**Figure 11.22**  
Shoulder abduction  
- Arm out to side, palms up.



**Figure 11.26** Elbow flexion – Bend elbow.



**Figure 11.23** Shoulder abduction – Arm across body.



**Figure 11.27**  
Elbow extension  
- Straighten elbow.

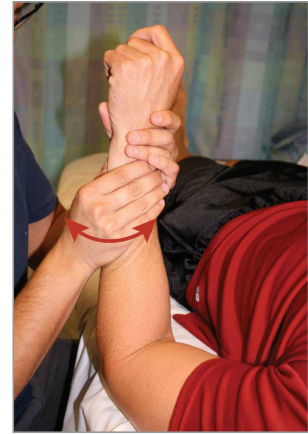

**Figure 11.28**  
Forearm pronation and supination  
- Palms up/palms down.



**Figure 11.24** Shoulder abduction – Arm across body.



**Figure 11.29**  
Forearm pronation and supination  
- Palms up/palms down.



**Figure 11.30**  
Wrist extension with finger extension - Straighten wrist with fingers closed.



**Figure 11.25** Shoulder external rotation.





**Figure 11.31** Wrist flexion with finger extension  
- Bend wrist with fingers open.

### SPASTICITY

Spasticity is very common after a spinal cord injury. It affects some, but not all, patients depending on the type of injury and usually begins a few weeks or months after the injury. Persons with spinal cord injuries often describe spasticity as involuntary movements, muscle spasms, twitches or shaking. This abnormal muscle activity is caused by reflexes that are normally inhibited by signals traveling from the brain. However, when the signals that travel up and down the spinal cord between the brain and the body are disrupted by an injury, spasticity may develop.

There are two major types of spasms: extensor spasms (straightening) and flexor spasms (bending). Spasticity may also be described in terms of the specific muscles it affects.

Any stimulus below the level of injury can cause spasms. These stimuli can include: touch, pressure ulcers, irritated skin or fever from any source including bladder infections. The degree of spasticity can range from mild to severe, and may have varying effects on your ability to function.

### Advantages of Spasticity

- An increase in spasticity can warn you of a problem in an area where there is no feeling. The problem could be a urinary tract infection (UTI) or a pressure ulcer.
- Spasms help maintain muscle size and bone strength.
- Spasticity may increase your ability to perform activities such as transferring or walking.
- Spasms can increase blood circulation in the area of the spasm.

### Disadvantages of Spasticity

- Spasms may keep you from sleeping.
- Spasticity may cause pressure or shearing forces on the skin, as well as bumping and rubbing of body parts, all of which can lead to skin breakdown.
- Severe uncontrolled spasticity may cause limitation in your joint movements, which may lead to contracture.
- Spasticity may interfere with function (transfers, feeding, dressing, etc).
- Spasticity or spasms may cause pain.

### Options for Managing Spasticity

- Perform daily ROM exercises.
- Participate in a standing program.
- Avoid extra stimuli, such as certain positions or fast movements.
- Protect your legs and feet in bed and in your wheelchair by using splints, heel protectors or padded straps. This will help insure the protection of your skin.
- Control the stress in your life through stress management and relaxation.
- Talk with your physician or therapist about management techniques, including medications, injections, surgery, and intrathecal baclofen.

### HETEROTOPIC OSSIFICATION

Heterotopic ossification (HO) is the development of abnormal bone in tissue below the level of the SCI. HO occurs mostly in the areas around the hip, knee, shoulder and elbow joints. The cause of HO is unknown. It does not occur in all people with SCI.

Signs and symptoms of HO include limited ROM; swelling, redness and increased warmth in the affected area; increased spasms; fever; and limited ability to do activities of daily living.

If you suspect that you have HO, consult your doctor. Diagnosing HO may be accomplished by X-ray, blood test and/or bone scan. Medication is the treatment of choice, and it is most important to continue an effective ROM exercise program in order to avoid contractures. Surgery may be an option when indicated.

**POSTURE**

The key points of good wheelchair sitting are equal distribution of weight on buttocks and proper alignment and positioning. It's important to sit with equal weight over the hips and thighs, right to left and front to back.



**Figure 11.32** Poor wheelchair posture  
– Increased weight at tailbone and shoulders.



**Figure 11.33** Good wheelchair posture  
– Weight distributed at thighs, buttocks, back, trunk, shoulders, head.

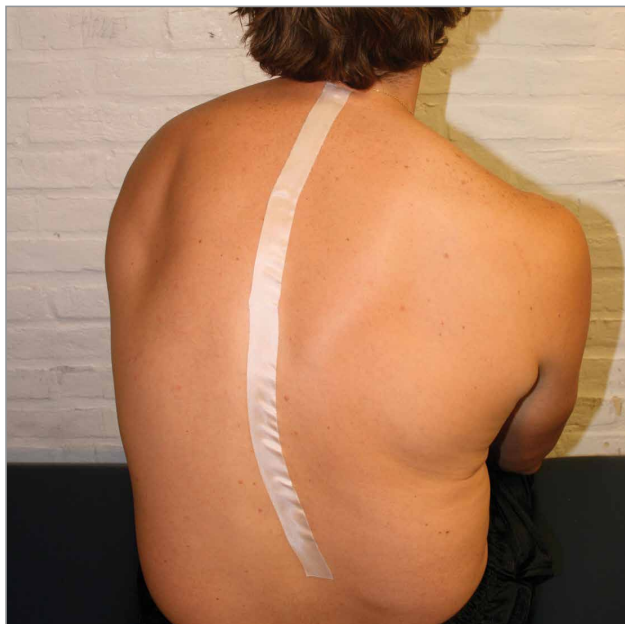

**Figure 11.34** Scoliosis.

Unequal weight distribution causes poor posture, which can lead to:

- Curvatures in the spine (scoliosis or kyphosis) that can cause difficulty with breathing
- Skin breakdown
- Decreased or impaired ROM
- Impaired mobility
- Increased spasticity or increased difficulty with spasticity management
- Inability to perform activities of daily living
- Pain (back, neck, etc.)

Other causes of poor posture may include:

- Muscle weakness, imbalance and tightness (especially in the neck, shoulder, trunk and lower back muscles)
- Limited ROM in joints
- Spasticity
- A chair back that is too low or too high
- A worn or inappropriate seat cushion or back support
- Footrest position at an incorrect height
- A wheelchair that is too wide or too narrow

**HIGHLIGHTS**

- Mobility-related skills include activities of daily living (feeding, grooming, dressing, etc.), bed mobility, transfer skills, wheelchair skills, standing and walking.
- Proper transfer techniques are important for you and your caregiver's safety and overall wellbeing.
- You will learn how to use your wheelchair to manage curbs, stairs, ramps and different terrain.
- Selecting equipment is important and involves your input, learning and understanding of the process.

**GENERAL INFORMATION**

In the previous chapters you've read about what happens to your body after an injury to the spinal cord. The goal of this chapter is to describe the types of mobility skills and equipment you will be introduced to during your rehab stay, as well as tasks that will enable you to function in your home and community.

Your therapists will work with you to establish the mobility skills and equipment that are best suited to you, your family or caregivers, and your environment. You and your caregivers will be taught how to perform and instruct others in these skills.

The training sessions are a very important part of your rehab. You'll identify the techniques and skills that are the easiest and safest for you to do, but you'll also practice the activities, strengthen the muscles and build the endurance you need to perform the activities throughout the day. Family members or other caregivers who will be assisting you with activities will also be involved in training sessions. It's essential that they learn proper body mechanics to keep themselves safe while assisting you.

Think of all the activities you do in a day. Think of all the places in your home and community that may now present some barriers to you as you move around in a wheelchair. These are some of the activities you will be concentrating on in your therapy sessions and practicing throughout the day while you are in the rehab hospital. They include activities of daily living (ADLs), bed mobility, transfers, wheelchair skills, standing and/

or walking. Equipment may be necessary to assist you or your caregivers with these skills. Your therapists will help identify the best techniques and equipment to meet your specific needs.

**Activities of daily living** include tasks such as eating/feeding, grooming/hygiene, dressing/undressing, bathing and adapted techniques as needed for self-catheterization and bowel program management. Equipment to assist with these tasks includes:

- **Bathroom equipment:** appropriate seating equipment for bathing and/or bowel program; adapted tools such as a long-handled sponge, hand-held shower, suppository inserter, digital stimulation extender, etc.
- **Dressing/undressing:** long-handled shoe horn, reacher, hospital bed rails to help with rolling and turning, button aids to assist with button fastening, etc.
- **Grooming/hygiene:** built-up handles or universal cuffs on brushes, toothbrushes, etc.
- **Feeding:** built-up handles/modified utensils to assist with feeding, cutting food, opening packages, etc. A mobile arm support can also be used to assist with self-feeding if your therapist feels that it's appropriate.
- **Computer and environmental control access:** adaptive telephone for emergency phone calls; voice control for word processing; switch activation for hospital bed control, light access, automatic door opening, temperature control, etc.

**Bed mobility** is about learning new ways to move around in bed. These skills include rolling from side to side or to your stomach if permitted, sitting up from lying down and lying down from sitting up. The level of assistance can vary from requiring total assistance to some assistance from a caregiver to total independence.

Equipment that can assist with these transitions includes:

- **A hospital bed** with or without rails to assist with rolling and positioning
- Thigh loops or a leg lifter to reposition your legs

**Transfers** describe the way you move from your wheelchair to your bed, bathtub or shower equipment, couch, car, floor, aisle chair for airport travel, etc. Below are descriptions of different basic transfer techniques.

**The technique that you and your caregivers use will be specific to you and taught by your therapist.**



Please note: The use of good body mechanics is essential for the person performing the transfer. Please be sure to review body mechanics with your therapist before trying techniques at home.

Equipment that can be used to assist with transfers includes:

- **Sliding boards:** Different lengths can be used for different transfers. Certain board materials work better for some people than others; handholds on the board can assist with board placement. You will have the opportunity to try out different boards during your stay.
- **Mechanical lifts:** Power and manual hydraulic lifts are made by different manufacturers with different slings. You will be involved in selecting the best lift for you.



Figure 12.1 Dependent two-person lift.

**Dependent Two-person Lift**

1. The taller/stronger person is positioned behind the person being moved. He places his/her arms under the arms of the person being moved and grabs the opposite forearms (arms are crossed).
2. The person in front lifts under the thighs.
3. In a coordinated manner, the patient is lifted by both people and moved laterally to either the other surface or on/off the floor.



Figure 12.2 Dependent sliding board transfer.

**Dependent Sliding Board Transfer**

1. Position the wheelchair at an angle to the bed/ surface. Remove armrest.
2. The patient should be moved forward to the edge of the chair and the sliding board placed under the buttocks and thigh.
3. Lean the patient forward with head in the opposite direction of the surface to which you are transferring. In other words, the patient’s head and shoulders lean opposite the direction the hips will go.
4. The person performing the transfer should place his/ her hands under the buttocks and slide the patient across the board.



Figure 12.3 Mechanical lift (Hoyer lift).

**Mechanical Lift (Hoyer Lift)**

1. Place patient on his/her back and roll side to side to place the sling under the person being moved.
2. Attach the four corners of the sling to the lift appropriately.
3. Support the patient’s head and neck until in an upright position.
4. Using the lift, elevate the patient from the bed/ chair until he or she is in an upright position.
5. Once the patient is settled in the sling, move the lift appropriately to the new surface. Lower the patient slowly to the new surface and do not move away until the patient is secured.

These are very general instructions. You’ll need to work with your therapist to understand specifics best suited to your needs.



**Standing** can be an important part of your daily routine after SCI. It may offer many benefits such as stretching the joints in your legs, reduction of spasticity, relief of pressure on the buttocks, improved tolerance of the upright position, increasing blood flow, or improving digestion and breathing capacity. Current research, however, does not demonstrate a clear link between standing and osteoporosis prevention. Your therapist will help you develop an appropriate standing program that will meet your goals after discharge.

Equipment that can be used to help with standing includes:

- **Tilt table** which slowly brings you from the lying flat position into standing
- **Stall bars**, an inexpensive means of standing that utilizes straps to hold your legs in position
- **Standing frame**, which allows you to transfer into the seat and then pump the seat up into a standing position
- **Braces or lower-extremity orthotics** that hold your legs straight, coupled with a device such as a walker

**Walking** provides psychological benefits as well as exercise, strengthening and functional mobility. Depending on your level of injury, walking may or may not be something you choose to pursue. As with all other daily activities, you may need assistance with walking and equipment may also be necessary.

Equipment that may be used to assist with walking includes:

- **Braces or lower-extremity orthotics** necessary to protect your joints and allow you to be more stable
- **A walking assistive device** such as a walker, forearm crutches or cane to help you be more independent and safer with walking

**Wheelchair skills and stair skills** include going up and down curbs and stairs in your wheelchair or out of your wheelchair, popping wheelies, propelling your wheelchair on different types of floor surfaces and terrain (carpet, grass, gravel), pushing your wheelchair upright from a completely tilted back position, etc. If you will be bumping up and down the stairs on your buttocks, a Jay Protector® may be ordered to protect your skin.

For many of these skills, it is necessary to remove or flip up the anti-tipper bars or wheelie bars on your wheelchair.

**It is absolutely necessary to remember to replace or flip**

**down the bars after completing the skills (e.g., going up the stairs).** These bars are needed to keep you safe in your wheelchair and to prevent further injury from flipping backwards in your chair. The other significant pieces of equipment needed for these skills are your wheelchair and your cushion. The next section discusses the choices and options available for wheelchairs and cushions.

Please consult your therapist so you or your caregiver may be taught how to perform these skills.



Figure 12.4 Caregiver assist wheelchair up curb.



Figure 12.5 Replace anti-tipper bar.



Figure 12.6 Caregiver assist wheelchair up stairs.

**CHOOSING YOUR WHEELCHAIR AND CUSHION**

Choosing the most appropriate **wheelchair** and cushion is one of the most important decisions you'll make during your rehabilitation because it will affect your independence and your activities throughout your day. During rehab, you'll have the opportunity to try out various types of **wheelchair seat cushions** and **specialty backs** as needed to optimize your positioning. Take the time to think about each wheelchair frame and accessory and how it works for you.

In the process of selecting your equipment, you'll participate in **pressure mapping**, as needed, to select the best cushion. This mapping shows where areas of increased pressure are on your buttocks when you're sitting. The best cushion for you will minimize these pressures for better skin protection. Cushions that you might try include fluid, air and combination cushions.

After trying the various wheelchairs and accessories, a **wheelchair clinic** will be scheduled. This clinic allows the equipment company or vendor representative to meet with you and your occupational therapist for measuring and finalizing the wheelchair order.

**WHEELCHAIR FRAMES**

**Rigid**

Depending on the type of rigid frame chair that you choose, the following may be options: adjustable back height and angle, camber, rear wheel spacing.

*Advantages:*

- Durable
- Efficient ride (smooth)
- Lighter weight
- Can remove wheels
- Can change the center of gravity
- Decreased turning radius depending on the front angle chosen
- Depending on the type of material your wheelchair is made of, the shock absorbance quality will vary

*Disadvantages:*

- May be more difficult with some ADL and transfers
- Truly rigid wheelchairs may not be able to adjust squeeze (squeeze is the height of the wheelchair where the pelvis is located)
- **Depending on your vehicle, the chair may not fit in your trunk.**



**Figure 12.7**  
*Rigid frame wheelchair.*



**Figure 12.8**  
*Folding frame wheelchair.*

**Folding**

*Advantages:*

- Able to adjust width of chair with few parts
- May be easier to transport

*Disadvantages:*

- More moving pieces may increase maintenance/repair
- Less efficient propulsion
- Cross brace (X under chair) adds weight to chair
- May be heavier, depending upon the material that is used to make the wheelchair
- Minimal shock absorption

**CARE OF YOUR WHEELCHAIR**

**Daily Cushion Maintenance**

- For **fluid-filled cushions**, reposition the fluid before and after every transfer. Do not leave the cushion in extreme heat or cold.
- For **air cushions**, check the air pressure every day before you get in the wheelchair. Do not leave the cushion in extreme hot or cold.
- Hand wash and air dry the cushion cover weekly or when soiled.
- **Damage to or problems with your cushion can result in significant skin complications or wounds.**

**Weekly Wheelchair Maintenance**

Wheelchair maintenance is extremely important to keep your chair running smoothly and safely. Maintenance is your responsibility once you leave the hospital.

1. Clean the frame of the wheelchair with a spray cleaner. Wipe it off with a dry cloth.

2. Lint/hair should be removed from around the axles of the rear wheels and the casters. If not removed, you might experience “veering” to one side.
3. Upholstery should be washed with mild soap and water. Dirty upholstery will wear out faster and will develop an odor if not cleaned. Tighten screws to keep upholstery taut.
4. Wheels should be checked for loose spokes and worn bearings. Spin the wheel to see if it wobbles. If so, it probably means that some adjustment is needed to the spokes. A local bicycle shop or your vendor can make this adjustment.
5. Pneumatic tires should be tested for correct pressure. Check for rough edges on hand rims. Tighten hand rims and attach hardware if needed.

**Regular Maintenance**

1. Tires
  - a. Solid tires
    - Check for pronounced flattening of the outer surface, gouges and objects embedded in the tire.
  - b. Pneumatic tires
    - Check tread for excessive wear or patchy, uneven wear. Check treads and sidewalls for scrapes and cuts, and deterioration of the rubber.
    - Check air valve for damage and be sure the valve-cap is not missing.
    - Wipe soapy water over the tire to see where bubbles may rise. This will reveal air leaks.
  - c. Casters
    - Check for signs of bending on sides and stem. Be sure the stem is firmly attached to the fork.
    - Check stem bearing for excessive play both up and down, as well as forward and backward. Tighten as necessary. This is necessary if you are experiencing “fluttering.”
2. Brakes
  - Check brakes and adjust as necessary. Do not tighten them to where they peel the rubber off the tire.
  - If grade aids are used, check for proper operation.
3. Upholstery
  - Check for equal tautness of each upholstery piece. Slung seat or back upholstery may contribute to the development of pressure sores and pelvis misalignment.

4. Axles
  - Clean the axles with light oil (not WD40). Do not use too much oil as this may attract dirt/lint.
5. Camber
  - Difficulty with self-propulsion can be caused if the camber (angle of the tires) is not set to meet your needs. The camber increases the base of the wheelchair yet allows ease with hand rim access for propulsion.

**General Wheelchair Care Instructions**

1. Record the serial number of your wheelchair, and retain it for your future reference. This number may be important when ordering replacement parts.
2. Obtain the name, phone number, and address of the medical supply vendor who provided you with your wheelchair. You should contact the vendor if any problems occur with your wheelchair.
3. Understand your wheelchair warranty.
4. An annual maintenance review by the medical supply vendor is recommended.

All wheelchairs need regular maintenance and repairs. Plan to replace worn out wheelchair parts. If you need parts, locate your wheelchair vendor and call them; some parts for wheelchairs must be ordered from the manufacturer. Try to anticipate what your wheelchair will need and plan for this. Most wheelchair parts have to be paid for before the vendor will order them. Insurance and other payers will not always pay for repairs, and you may have to assume this cost.

Bike shops will often be able to assist you with changing tires, cleaning and tightening loose parts. You will have to instruct them regarding the assistance you need.

**CARE OF BATHROOM EQUIPMENT**

Several kinds of bathroom equipment are available that can make it easier for you to carry out personal hygiene activities. This equipment includes tub benches, shower commode chairs, hand-held showers, drop arm commode chairs, elevated toilet seats and grab bars. To keep this equipment in good working order, you should regularly carry out these maintenance suggestions:

1. Keep surfaces clean and dry.

2. Check for tears in the upholstery and repair or replace as necessary. Keep sharp objects away from plastic-coated seats.
3. Check that all screws are in place and tightened.
4. Check that all safety belts and straps are in good condition.
5. Check suction cups on tub bench and replace if not holding.
6. Make sure brakes are holding on rolling shower commode chairs.
7. Make sure grab bars are securely fastened and the proper bolts or screws are in place.

If you need replacement parts, contact your local medical equipment vendor. Your vendors are listed on the Discharge Information sheet that you will receive when you leave the hospital.

**CARE OF UPPER AND LOWER EXTREMITY BRACES (ORTHOSES)**

1. Leather should be cleaned with saddle soap and carefully dried.
2. Screws and rivets should be checked to make sure they are tight and working properly.
3. Plastic parts should be cleaned with soapy water, rinsed thoroughly and carefully dried.
4. Do not leave your plastic orthoses in extreme heat, as they may change shape.
5. Do not change brace alignment or structure without consulting with your orthotists, doctor or therapist.

**CARE OF ASSISTIVE WALKING DEVICE (WALKERS, CRUTCHES AND CANES)**

1. Make sure that rubber tips are clean. Replace them when worn.
2. Keep thread, string and other debris out of the wheels of the walker.
3. Replace handgrips when they are worn out.

**HOME ACCESSIBILITY AND MODIFICATIONS**

Most homes are not built with accessibility needs in mind. The Americans with Disabilities Act (ADA) has specific guidelines for accessibility, but each home has different needs. Therefore, it is very important to discuss your specific home with your therapy team to determine the best modifications for you.

General guidelines for accessibility follow for your reference:

**ASSISTIVE TECHNOLOGY**

Assistive Technology (AT) is a generic term that includes assistive, adaptive and rehabilitative devices and the process used in selecting, locating and using them. AT promotes greater independence for people with disabilities by enabling them to perform tasks that they were formerly unable to accomplish, or had great difficulty accomplishing, by providing enhancements to or changed methods of interacting with the technology needed to accomplish such tasks.

Some common types of assistive technology include:

- Seating and positioning
- Low-tech devices such as reachers, sock aides, long handled sponges and adapted eating utensils
- Commercially available products that can be modified to meet the needs of a person with a disability and used in new or innovative ways
- Computer access (includes alternative access to keyboard and mouse, speech recognition software)
- Electronic aids to daily living (access to home environment including opening doors, turning on lights, fans, TV, CD player, attendant call light and other electrical devices within the home)

**Computer access** involves:

- Various input devices that take the place of a mouse. Because a mouse can be difficult for people with limited hand function to use, there are additional pieces of equipment that are easier to access. These may include a trackball with programmable buttons, a joystick controller or a system that can be operated through eye or head movement.
- Several types of keyboards also exist. Smaller keyboards can be used with mouthsticks, and keyboards with very large buttons are available for people who have trouble accessing the standard size. Other keyboards include ergonomic keyboards, one-handed keyboards and colored keyboards.
- Voice-recognition software is a very popular option for computer control and is becoming more reasonably priced. Voice recognition software can be installed on either desktop PCs or laptop computers and requires the user to wear a headset. Out of the box, voice



recognition software is good. With continued training, the software can be invaluable to the end user. An individual can navigate the Internet and access all commands on the computer via voice recognition.

**Electronic Aids to Daily Living (EADL)** are systems that allow for independent access to the environment after an illness or disability compromises it. These devices may compensate for limitations in hand function or reach from a wheelchair, which is common after a spinal cord injury. An EADL system can allow a user to control appliances including, but not limited to, doors, lights, fans, radios and televisions. This is important for both medical necessity and quality of life benefits.

Control of the EADL system is typically accomplished by switch access. A switch is the interface between the user and the EADL system. A technology specialist can help to identify an appropriate switch access site that is efficient and reliable. Common switch sites may include the use of hands, elbows, head and/or feet to send messages to the EADL device, which in turn controls the specified appliance. Sip and puff, as well as voice activation, can also be considered.

An individual should be evaluated by an assistive technology practitioner (ATP) or supplier (ATS) to determine the most appropriate computer access and environmental control options. They should also provide the necessary training to ensure proficiency.

**HOME MODIFICATION IDEAS AND SUGGESTIONS**

**The following are recommendations based on ADA guidelines. Please contact your therapists or licensed professional contractor regarding specific recommendations for your home.**

**OUTSIDE HOME**

**Parking**

- Reserved space in apartment (contact apartment manager to see if a place can be reserved)
- 13-foot-wide space in garage to transfer/unload, at least 5 feet on side of car
- Automatic garage door openers – need 25-foot-long garage to accommodate van with tailgate

**Walkway**

- Level and non-slip surface
- Minimum 48-inch width

**Ramps** (See Figures 12.9 through 12.12 for ramping guidelines)

- 12 inches in length for every 1 inch rise; i.e., for every 1 inch in height the ramp must be, you need 12 inches (or 1 foot) of length; \*20 inches to 1 inch for exterior if snow, ice, etc., are a factor
- 36- to 48-inch width
- Bilateral guard rails 30 to 32 inches high (width of railing grip 1.5 inch). Extend rails 1 inch beyond the end of the ramp and make sure the ends of the railing are not hazardous.
- 4x4-foot level landing
- If door opens out, need 5x6-foot level landing.
- If ramp changes direction, reaches 30 feet, or rises higher than 3 feet, provide a 5x5-foot level landing to turn or rest.
- 4-inch curbing border for ramp and platform to prevent wheelchair from falling off the ramp.
- Overhead coverings suggested

**KITCHEN**

**Stove/Oven**

- Electric preferable to gas
- Mounted cooking top with staggered burner arrangement

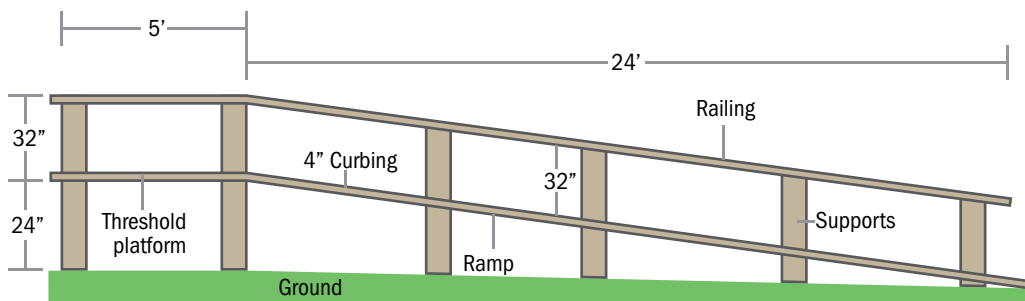

Figure 12.9 Lateral view of ramp measurements.

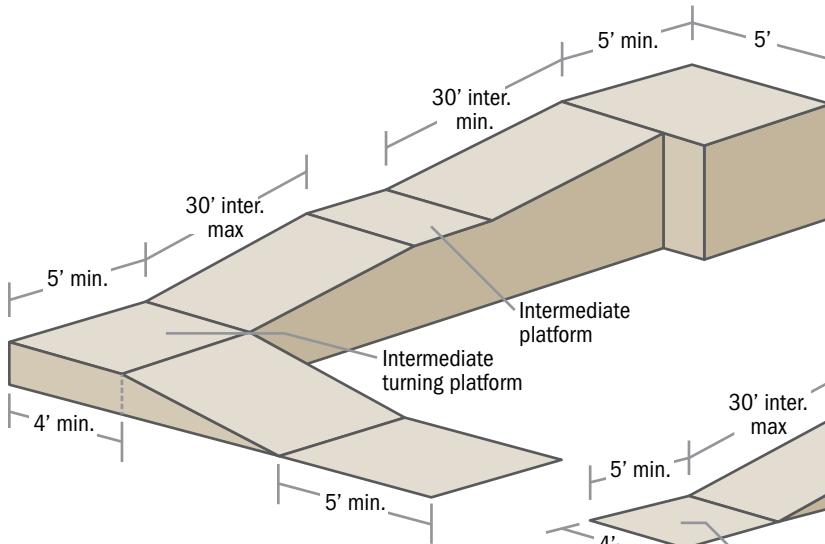

Figure 12.10 Ramp with turning platform.

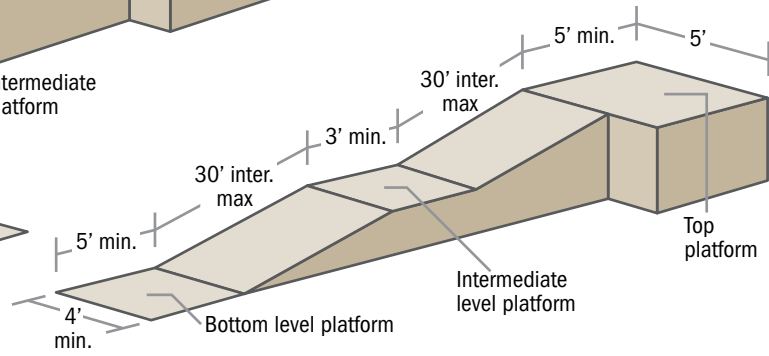

Figure 12.11 Straight ramp.

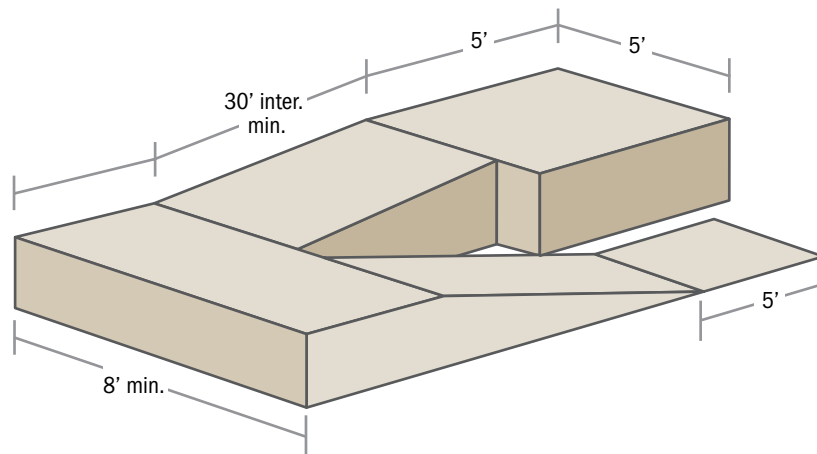

Figure 12.12 Ramp with intermediate switch-back platform.

- Mirror mounted at angle above burners
- Wall mounted oven, with drop front door
- Oven door should allow you to roll under when open (29.5 inches from floor)
- Front of counter no more than 40 inches from floor; rubber cane tip dowel through control can help with dexterity
- Contrasting markings for temperature settings

**Cabinets/Counters**

- Minimum of 5 feet clear floor space between cabinets and walls
- Toe space of 6 inches in depth recessed, and 8 to 11 inches in height under cabinets allow footrests under cabinets to get closer

- Space underneath cabinet should be 28 to 30 inches wide, 27 to 30 inches high and 21 to 24 inches deep
- Insulate pipes under sinks to protect legs from possible burns
- Create a work triangle for stove, refrigerator and sink area to conserve energy and to function efficiently
- Sink should be shallow enough to place hands flat on bottom, 30 to 34 inches from floor and
- 4 to 5 inches deep
- Single-lever faucets are easier; mount to right or left instead of in back.
- Counters used as work surface should be 30 to 34 inches high and 16 to 18 inches deep.
- Under the counter storage: roll-out shelves or bins are best



**Refrigerators** - Side-by-side recommended

**Dining area**

- Open leg space
- 30-inch height
- 30-inch table top space

**BATHROOM**

- 45- to 55-square-foot floor space
- Open floor areas 5 feet in diameter to allow for turning
- Mirrors/medicine cabinets – top shelf not more than 50 inches from floor and bottom shelf 40 inches from floor
- Outlets, towel racks, light switch outside the door, and soap dishes mounted not over 40 inches from floor

**Sink**

- 27- to 30-inch clearance under sink; therefore sink should be approximately 34 inches from the floor
- 27 inches deep
- Insulate pipes under sink to protect legs from possible burns
- Use lever handles

**Toilet**

- Ideal height of toilet is dependent upon patient’s transfer status
- 15 to 16 inches standard, 19 to 20 inches elevated
- Shower commode chair will roll over standard-height commode
- Leave space along sides for wheelchair
- Grab bars – need to withstand 250 pounds and be mounted to wall studs
- Optimum diameter for grab bar, 1.25 to 1.5 inches for adults, 1 to 1.25 inches for children
- Distance between wall and grab bar 1.25 inches

**Bathtubs/Shower**

- Rim not lower than 18 inches from floor
- Please alert therapist if you have a garden tub or specialty tub, as it may affect equipment ordering
- Shower stall should be 5 feet x 5 feet for commode chair
- Shelving 54 inches maximum height from floor
- Set water heater thermostat to medium setting (120 degrees Fahrenheit maximum) or use anti-scald mechanism on individual faucets

**BEDROOM**

- Height of bed level with wheelchair 18 to 20 inches with 10- to 13-inch clearance under the bed to

accommodate a mechanical lift (if needed)

- Have enough clearance alongside bed to accommodate wheelchair (approximately 3 feet, 8 inches)
- Have within reach of bed: lightswitch, telephone, intercom, clothes

**Closets**

- Lower bars 36 to 48 inches high
- No deeper than 16 inches
- Open shelving
- Maximum height for top shelf should be 54 inches from the floor
- Folding/sliding doors or curtains are easier

**DOORS AND HALLWAYS**

- Width of doorway should be 1.5 to 2 inches wider than overall width of wheelchair
- Doorways leading off 36-inch-wide hallway should also be 36 inches wide to allow wheelchair to pass through doorway, or 48 inches wide
- Doors that open out or pocket doors make better use of space inside the room
- Low door threshold (sill)
- Remove screen door if access is problem
- Use latch door handle at 36 to 44 inches high or attach leather strap
- Recessed hinges enlarge doorway by 1.5 to 1.75 inches
- Add rope pull or extra handle in middle of door for easier reach to close
- Kickplate prevents wear on wheelchair and on door
- Removing door provides additional 1.5 to 2 inches; removing door jamb and molding provides additional space
- Removing doorstops adds 3/4-inch additional space
- Exterior threshold should be beveled with maximum 3/4-inch edge height

**STAIRS**

- Handrails should be mounted 1.5 inches from wall and should support 250 pounds
- Vertical rise greater than 6 to 7 inches is dangerous and difficult
- Suggested that the horizontal part of the stair (tread) be 11 inches

**HIGHLIGHTS**

- Your spinal cord injury does not mean that you have changed but that the way you do things has changed.

The emotional reactions following a spinal cord injury are similar to the emotions experienced in the grief process when anyone copes with a significant loss. Some of the most common emotions that people experience following SCI are sadness, anger, fear, shame and anxiety. You may experience these emotions but it's important to remember that you can deal with them and feel positive about yourself and your future.

- Some of the ways you can deal with your emotions are by:
  - Changing the way you talk to yourself
  - Changing feelings by increasing your understanding of yourself
  - Changing feelings by changing behavior
  - Changing the way you communicate your feelings
- Abuse of alcohol and drugs is a negative way of coping with your feelings.
- Resources are available to help if you find that you are having difficulty coping with your spinal cord injury.

**WHY DID THIS HAPPEN?**

It's difficult for any of us to accept that something bad can happen to us. We tend to take our good health and physical condition for granted. We think physical disabilities happen only to other people.

Then something does happen – an accident, the sudden onset of an illness – and you find yourself disabled. Your abilities have changed, and you may now need others to help you tend to your basic needs.

Your first thought may be: Why did this happen to me? What did I do to deserve this? You're bombarded with new words like paraplegia, tetraplegia, Foley catheter and bowel program. You think of all the things you used to do and how easy it was. You think about your appearance and imagine how your family and friends may feel when they look at you. You may ask yourself, will they still love

me? Will they stay by my side through all of this? What do they think about me now? Your list of concerns may grow and so does your fear and frustration. You may feel that you have lost control of your life.

**WHO AM I?**

If your body and its functioning have changed, you may feel you have become a different person. How we see ourselves and how we function reflect "who we are."

Remember, **you are still you**. As you work to cope with your injury, you gain a renewed sense of self. The changes are in how you do things. As you learn to understand and deal with these changes, you'll discover ways to meet these challenges. You had challenges before. You have new and different challenges now.

With time, you will redefine yourself in light of the changes in your life due to your spinal cord injury. You have the opportunity to reassess your capabilities and limitations, not only physically, but emotionally and spiritually. You'll discover that you're far stronger than you ever imagined you could be, and that you have the will and the courage to make a new life for yourself. It's now up to you to reach out and discover the meaning of that new life. There are people who are waiting to help you.

**HOW DOES THIS AFFECT MY FAMILY AND FRIENDS?**

Family and friends are great support systems, but remember that the significant others in your life probably have experienced the same emotions that you did in reaction to your injury. Like you, they also need time to adjust.

They may have questions and concerns regarding your spinal cord injury. Honest and direct communication is the key to strengthening this mutual support system. You and your family are encouraged to participate in setting your rehabilitation goals, in education and training opportunities and in preparing for your discharge from the hospital. Resources in the hospital are available to help you and family cope. Community resources are available after discharge to continue to help if necessary.

While some relationships will grow and strengthen during these times, some may not last under the pressure of major change. It's important not to accept personal responsibility for another person's decision to change or end a relationship.

## EMOTIONAL REACTIONS TO SPINAL CORD INJURY

The emotional reactions following a spinal cord injury are similar to the emotions experienced in the grief process when anyone copes with a significant loss. After a spinal cord injury, you may experience a range of emotions. What you experience depends on who you are, what you were like before the injury and how you deal with difficult situations. It's helpful to understand the emotions you're feeling and to allow your feelings to be expressed. When you don't express your emotions, they may lead to physical and emotional damage. Below are some of the most common emotions that people face after being injured.

### Sadness

Some people call it depression; others call it feeling "blue," "down" or "bummed out." No matter what you call it, sadness hurts and you want it to stop. After the injury, you will likely grieve for the "able-bodied" person you used to be. Find the way that best helps you express your sadness.

### Anger

Anger can be healthy if the energy that feeds anger is channeled in productive ways. It can give you that push to accomplish when you think there's nothing else left to drive you. On the other hand, there are unhealthy kinds of anger that can lead to negative behaviors such as yelling at loved ones, refusing to get out of bed, not doing exercises or turning to alcohol or drugs. Find ways to release anger in appropriate and healthy ways.

### Fear

Fears that people may experience following SCI include:

- The unknown
- Isolation
- Life changes
- Dependency
- Loss of control
- The future

When you identify the fear, you are more likely to find a way to minimize and manage it.

### Shame

With all the things that change after spinal cord injury, it's not unusual to feel embarrassed or ashamed about your disability. You may need time to adjust to and accept your new body. But remember, you are the same person you were before.

### Anxiety

Anxiety may cause you to worry, or feel nervous, jittery or shaky. You might feel out of control. You do not know if you will recover or how you will accept it if you do not. You may wonder if people will love and care about you. By talking about your concerns, you may learn strategies to manage the anxiety.

### Maintaining Hope

Hope is the light that helps us see where we are going, the fuel that keeps us moving down the road. Hope prevents us from giving up when it would be easy to do so. It enables us to see that things have a way of working out. Hope may bring us comfort when nothing else seems to do so. Hope makes everything seem possible. We all live with hopes about ourselves and our futures.

### Coping with Feelings

As you are dealing with your SCI, you will receive significant support from other people in your life. However, your most valuable resource is you. Some ways you can deal with your emotions are:

#### *Changing the Way You Talk to Yourself*

Your "self-talk" (or how you talk to yourself) determines how you feel about yourself at any particular time. If your self-talk is filled with negative messages, your self-esteem and self-confidence will be low. To assess your self-talk, consider the following:

- What am I telling myself?
- Is my self-talk helping me?

In response to the above:

- Reject any negative messages and replace them with supportive statements.
- Develop a plan of action to deal with the problem in light of these positive statements.

By examining your self-talk, you may discover that a fear you have is unfounded. Or the anger you feel is misdirected. Once these reactions are identified, you can reassure yourself with your strengths and resources. With practice, you'll learn to talk to yourself in more positive ways. Decide what you can and cannot control. You may not be able to control what others think of you, but you can control how well you care for yourself and how you present yourself to the world. It's up to you.

### *Changing Feelings by Increasing Your Understanding of Yourself*

Self-exploration leads to insight and knowledge about yourself. Changes resulting from a spinal cord injury are an opportunity to learn more about yourself and how you cope. Most people feel that there is something beyond common human experience, something that gives hope, meaning and purpose to life. Some people meet this need through being part of an organized church or religious group. For others, spirituality is a more private pursuit.

If you find that your coping efforts are not successful, it's very important to reach out to someone you trust. This can be done with the aid of a social worker, psychologist or other trained counselor. They can help you see patterns, which might not be as clear to you, and then help you change these patterns into healthier ways of feeling and living. The person you reach out to could also be another healthcare provider, a friend, family member, pastor or clergy, teacher or anyone willing to acknowledge your concern and help you find ways to cope.

You may want to learn about support groups, organizations and agencies in your community that offer information about resources for people with disabilities. For a list of suggestions, see Chapter 15, Living, or ask your social worker.

### *Changing Feelings by Changing Behavior*

By examining your behavior, you find ways to feel more positive about yourself. Once you act differently, you may feel differently. For example, you may avoid going out with a friend, believing people will stare because you use a wheelchair. If you can take the risk and join your friend, you're likely to feel pleased with yourself that you went out. At first, it may seem like you are "faking it," but eventually your feelings will catch up with your positive behavior. Adjustment is adapting to change. It helps you to see that things have a way of working out.

Establishing a daily routine can help give you a sense of control. It can help you organize and maintain your personal care needs. Ways to help organize:

- Make lists. First thing in the morning or at the end of the day, list all the things that you wish to accomplish that day or the next.

- Try blocking out your time by the hour or the half hour. Estimate the time you need to get ready in the morning for appointments and activities or people you want to see.
- Set priorities. Decide what is reasonable to accomplish. Rest and take breaks when you need them.

Some behavior changes that lead to feeling changes are:

- **Treat yourself.** You can feel better about yourself by setting aside some time each day to do something you enjoy. Do something that says that you care about you. Treat yourself to something special.
- **Spend time improving your relationships with others.** Call a family member or a friend. Write a letter to someone you have not been in touch with for a while. People are more likely to respond to you if you take the first step.
- **Do something productive.** Read a book you have always wanted to read or work on a project or hobby. Explore vocational opportunities, going back to school or doing volunteer work. The size of the project is not important; just do something that makes you feel that you have expressed your creativity.

### *Changing the Way You Communicate Your Feelings*

Communication is an essential part of dealing with your emotional reactions and adaptation to SCI. Each of us communicates in different ways; some ways are more effective than others.

**Passive.** You hold back your true thoughts and feelings. You allow others to make decisions for you.

**Aggressive.** You dominate the situation. You make decisions for others, violating their rights.

**Assertive.** You are honest about your feelings, thoughts and attitudes. You stand up for your rights while at the same time not violating the rights of others.

Many of us use each of these communication styles from time to time. Do you recognize the communication style you use most often? Being assertive most of the time makes communicating with others much easier. The key is to be as direct as possible, but in a caring way. That's not always easy. You may find it difficult to be assertive with certain people. Perhaps it's easier to assert yourself with strangers than with your family members or your personal caregiver, or vice versa. Sometimes mental and emotional

blocks stand in the way of asserting ourselves. Some of these blocks may include the fear of being rejected, making someone angry or being thought of as foolish.

To overcome these blocks, try the following approach: State your feeling about a particular action. For example, “I feel helpless when you push my chair without asking me first.” By utilizing this approach, you can communicate your thoughts, feelings and emotions clearly and objectively to others. You also appear non-threatening, and you allow for a response from others. When you are speaking, also keep in mind that it is important that your body language match your words. Maintain direct eye contact and speak clearly and audibly. Use facial expressions for emphasis. Being assertive with others is a skill that takes time to learn, but is worth learning.

### **Problem Solving and Coping**

While a patient at TIRR Memorial Hermann, you may attend a RAPS (Readiness And Preparation for Self-care) class called Problem-Solving and Coping. The following is a sample list for positive and negative coping strategies developed in the RAPS class.

#### *Positive Coping Mechanisms*

- Deep breathing and relaxation exercises
- Positive visualization
- Asking for help
- Patience
- Meditating
- Praying
- Being thankful
- Laughter
- Education of self and others
- Acceptance
- Family support
- Talking to TIRR Peers
- Crying

#### *Negative Coping Mechanisms*

- Acting out
- Isolating yourself
- Refusing treatment
- Hitting
- Using alcohol and illicit drugs

### **Substance Abuse**

#### *What is meant by substance abuse?*

Use is not the same as abuse, and abuse is not always a sign of addiction. The following are signs that you have a drug or alcohol abuse problem:

- You need more drug/alcohol for the same effect, or there is a decreased effect with regular use of the same amount.
- You have a desire or need for daily use to feel normal or function adequately.
- You use drugs when you had intended not to.
- Your personality changes (more moody or withdrawn) with drug or alcohol use.
- You are intoxicated throughout the day.
- You have lost interest in activities that used to be interesting.
- You are unable to cut down or stop use.
- You spend a significant amount of time or effort to acquire the substance.
- You fail to meet important obligations to family or friends.
- You are frequently absent from work or school.
- You have lost a job or have legal difficulties.
- You are unable to remember what happened the night before, when drinking or using drugs.
- You have feelings of anger or avoidance when discussing your use.

#### *What are “substances of abuse”?*

These are alcoholic beverages and other mood-altering substances that are used inappropriately. They include both legal drugs, when taken in excess or without a prescription, and such illegal drugs as cocaine and marijuana. The following are categories of drugs most often abused:

**Stimulants** or “uppers” are drugs that stimulate the central nervous system. These include amphetamines, cocaine, caffeine (caffeinated coffee, tea and colas) and nicotine (cigarette smoking).

**Hallucinogens** are substances that affect perception (level and accuracy of awareness). These substances produce hallucinations and delusions. Examples of hallucinogens include psychedelic drugs like LSD and PCP.



**Depressants** are drugs that slow down (depress) the central nervous system, causing drowsiness or sleep and slowed breathing and circulation. Examples include alcohol, tranquilizers, sleeping pills and drugs used to treat anxiety or nervousness.

**Inhalants** usually fall into one of the above categories.

**Prescription drugs** (for example, pain medications) may be a source of substance abuse if not used according to your physician's orders.

#### *Facts About Substance Abuse and Traumatic Injury*

- More than half of all traumatic injuries occur following alcohol or other drug consumption.
- If you had a substance abuse problem before your spinal cord injury, the problem is likely to continue or worsen after your injury.
- Chronic stress or health problems influence the tendency to use/abuse drugs or alcohol.
- A disability is not an excuse to abuse drugs or other substances.
- If you have a spinal cord injury and abuse alcohol and other drugs, you are at a much greater risk for developing pressure ulcers due to poor nutrition and are less likely to do your weight shifts. Treatment of pressure ulcers can be very expensive, both in financial costs and loss of time from an active life.
- Mixing alcohol or illegal drugs with prescription medications is dangerous and can affect recovery. It can also be fatal.
- Public substance abuse programs are required by law to provide complete access to their facilities so that individuals with a disability may participate fully and equally.

#### *Tolerance, Physical Dependence and Addiction*

**Tolerance** develops when a particular dose of a drug begins to lose its effectiveness. Tolerance does not necessarily lead to addiction. Most people who drink a moderate amount of alcohol develop a mild tolerance.

**Physical dependence** exists if you have withdrawal symptoms when you suddenly stop taking the drug, and if you have increased tolerance (see above) to the drug.

**Addiction** is a behavior pattern of actively seeking and using a particular substance or drug. There is a tendency to "relapse" or return to this behavior after stopping the drug. Addiction is thought to involve emotional, social, biological and environmental factors existing before the person was exposed to the drug of abuse.

There are self-assessment tools that can be used to help you determine whether you have a problem with substance abuse.

#### *The CAGE Questionnaire*

1. Have you attempted to **Cut** down on drinking or drug use?
2. Have you ever felt **Annoyed** with criticisms about your drinking or drug use?
3. Have you ever felt **Guilty** about drinking or drug use?
4. Have you ever used alcohol or other drugs as an **Eye** opener?

**Answering "yes" to any two of these questions means you need to question your own use pattern.**

No one, under any circumstances, has ever been better off using drugs. If you are using drugs and alcohol, think about what you are doing to yourself and the pain you are causing yourself and people who care about you.

Substance abuse affects your mind and body. It affects all your social support systems, especially your family. It affects your rehabilitation process and deprives you of making gains after your injury. If you find that you are having difficulty with substance abuse, please refer to the resources listed for this chapter at the end of the manual. If you're still a patient at TIRR Memorial Hermann, please contact your social worker or physician.

**HIGHLIGHTS**

- Sexuality is more than physical; it is also our thoughts and feelings and our relationships with others.
- Experimentation and communication are important in dealing with sexuality issues.
- Changes in physical sexual function following SCI will vary based on level of injury, extent of injury to the spinal cord and time from onset.
- Sexual enjoyment following SCI need not be limited by changes in movement, sensation or function.
- There are a variety of techniques and positioning options that can assist you as you explore sexuality needs after SCI.

**WHAT IS SEXUALITY?**

Sexuality means many things to many people, and can be experienced in a variety of ways. It's not uncommon following SCI to focus initially on the physical part of sexuality. Since SCI can limit physical feeling and movement, it often leads to questions about physical performance during sexual activity. However, if your focus is only on the physical aspects of sexuality, it can be more difficult to deal with sexual concerns.

Sexuality also involves our thoughts and emotions, and how we relate and interact with others. It's much more than what happens in bed. It means being able to express yourself and enter into a relationship with someone else. It's important to learn to feel good about your body and yourself as a person. You may wonder whether anyone will think of you as sexy, or whether you will feel sexy again. Seeing yourself as being attractive and desirable is a large part of your sexuality, and it comes from having a positive self-concept. Feeling good about your sexuality will help you to better express yourself in a relationship with a significant other.

Part of rehabilitation is learning how your body works after SCI. In the same way, experimentation helps you to know more about your sexual responses. You are then better able to use this information to please yourself and to communicate your needs to someone else.

**COMMUNICATING YOUR NEEDS**

Since your injury, you have probably needed to rely on other people more than ever before. You've probably needed to learn new communication skills to enable you to ask for help. These same skills are important in a sexual relationship.

Remember that the people close to you or someone to whom you are attracted may not know how your injury affects your sexuality. You need to talk to your partner about how you feel about yourself and your relationship. It's also very important that you and your partner talk about your physical abilities: what assistance you may need, what feels good to you and what pleases both of you. Sharing your feelings will make your relationship stronger and more satisfying.

We often assume that we know what pleases someone else. These assumptions may not be accurate. Remember, your partner is not a mind reader and neither are you. So, developing good communication skills minimizes the chance of wrong assumptions and increases the opportunity for a greater variety of options.

Please refer to Chapter 13 for more information on developing communication skills.

**SEXUALITY AFTER SPINAL CORD INJURY**

There is no need to think that sex life ends after spinal cord injury. Society gives us a picture of what it is to be a desirable man or woman. This picture may not include a wheelchair, braces or crutches. However, many people who have been through rehabilitation return and share with us that they are involved in very satisfying relationships, emotionally and physically. They're able to both give and receive pleasure in a variety of ways.

In learning more about sexuality after spinal cord injury, it may be helpful to first review general information about male and female sexual function, anatomy and the genital (sex) organs.

**General Information: Male**

Figure 14.1 shows a side view of the inside of the male sexual (reproductive) system. The **testes** are inside the **scrotum**. The testes produce the sperm, which can fertilize the female egg and cause pregnancy. The testes also produce hormones. The sperm is stored in the **epididymis** until it is **ejaculated** through the **vas deferens** and **urethra**. On the way, fluid is added to the sperm from the **seminal vesicle**, **Cowper glands** and the **prostate gland**. These fluids or secretions are what make up the white, cloudy substance that is ejaculated. The brain and spinal cord work together to send and receive messages to carry out this process.

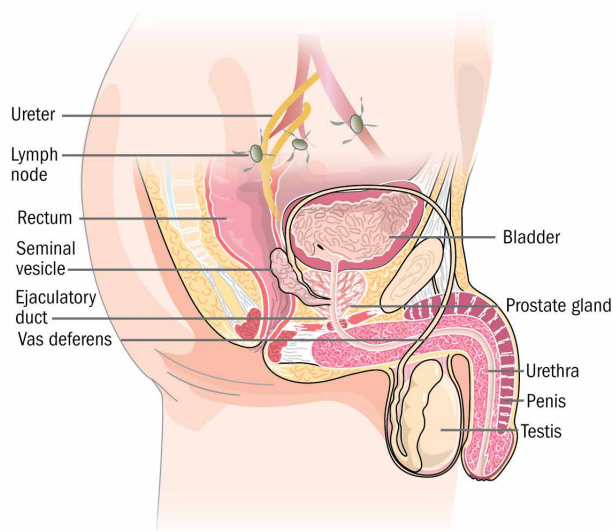

**Figure 14.1** Shows Side View of Male Reproductive System

After a spinal cord injury, you may notice changes in erection and ejaculation. The nerves that are responsible for erection and ejaculation are the second, third and fourth sacral nerves.

**Erections**

Erections may change after spinal cord injury. An erection occurs from sexual excitement when the shaft of the penis fills with blood. This allows the penis to become hard and erect. There are three types of erections:

**Psychogenic** erections occur from thinking about something sexy or sensuous. Thinking about your partner, smelling the same type of fragrance your partner wears or just seeing something that “turns you on” could cause a psychogenic erection.

**Reflexogenic** erections occur when the genitals are touched by stroking or even by applying an external catheter or condom. The reflex process occurs in the spinal cord. The message does not come from the brain as it does in the psychogenic type. All males have the capacity for this type of erection starting at birth. Any type of touch to the scrotum, penis or anal area may cause this type of erection.

**Spontaneous** erections occur when the bladder is full, especially after sleeping. It is believed that this type of erection comes from some type of internal process.

After a spinal cord injury, your penis may respond differently. This depends on two things: where the injury is located on the spinal cord and how complete the injury is to that level.

If your injury is located in the lower lumbar or sacral area and is incomplete, an erection from thoughts, sights or smells (psychogenic) may occur. This is because the area responsible for this type of erection is located between T-11 and L-2. However, if your injury is above that level, the message from your brain may not get through the injured part of the spinal cord. The reflexogenic erection (one that comes from touch) can still occur if the S2, S3, and S4 areas of the spinal cord are still intact.

Many men will have the ability to have an erection after recovery from spinal shock. It is very important to notice what causes the penis to get erect. One of the best ways to find out if it will become erect is by masturbating.

Contact your doctor if you experience trouble achieving or maintaining an erection. Your doctor may refer you to a specialist to have a complete exam and testing.

There are several options for assisted erections:

**Oral Medication.** A physician may prescribe medications that may help in acquiring an erection.

**Stuffing.** Technique whereby the soft penis is stuffed into the vagina either by the male or female. An erection may occur from pressure and friction.

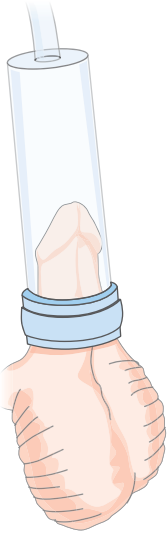

**Figure 14.2** Hollow tube placed around penis.

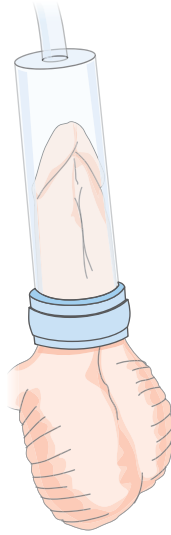

**Figure 14.3** Draws blood into shaft of penis.

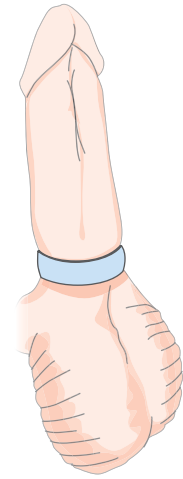

**Figure 14.4** Blood stays in penis due to rubber band around base of penis.

**Vacuum device.** A hollow tube that connects to a hand- or battery-operated pump. The action of this device creates a vacuum around the penis by drawing blood into the shaft. Blood stays in the penis by applying rubber rings around the base of the penis. A prescription is needed for this device.

**Injections.** A doctor, usually an urologist, can order certain drugs to be injected directly into the penis. A complete exam and close follow-up have to be done by an urologist before this method can be prescribed.

**Penile prostheses.** Prosthetic rods are surgically inserted into the shaft. There are several different types available. The doctor will not consider this method for at least 18 months to two years after the injury. This is the period of time required to allow evaluation of the return of movement/sensation after spinal shock. You cannot revert to other methods after this procedure.

### Ejaculation

A message to trigger ejaculation is sent to the brain and the brain sends the message back to the muscles in the **vas deferens** to force the sperm up and out. If the sacral nerves do not receive the message, ejaculation may not happen.

Part of the process that allows ejaculation to occur is the closing of the internal bladder sphincter. This causes

sperm-filled fluid to go past the bladder and out through the penis. In men with spinal cord injury, **retrograde ejaculation** can occur. This means the fluid goes up into the bladder because the sphincter did not close. Men with an incomplete injury are more likely to ejaculate than those with complete injuries.

Even men who can ejaculate may not be fertile. If the sperm count is low, the process of fertilization of the egg may not occur. However, until a doctor completes a sperm count, some method of birth control should be used to avoid pregnancy.

### General Information: Female

Figures 14.5 and 14.6 show the female sexual anatomy. The vagina is the female organ for sexual intercourse. Its opening lies below the urethra. The vagina serves as the entryway for the penis and sperm during sexual intercourse, as the birth canal and as the passageway for menstruation.

The **clitoris** is located above the urethra. It is a spongy tissue that fills with blood when it is stimulated or touched. This tissue is very sensitive and when touched can provide sexual excitement and pleasure. However, if stimulated too much, it can feel irritated or even painful.

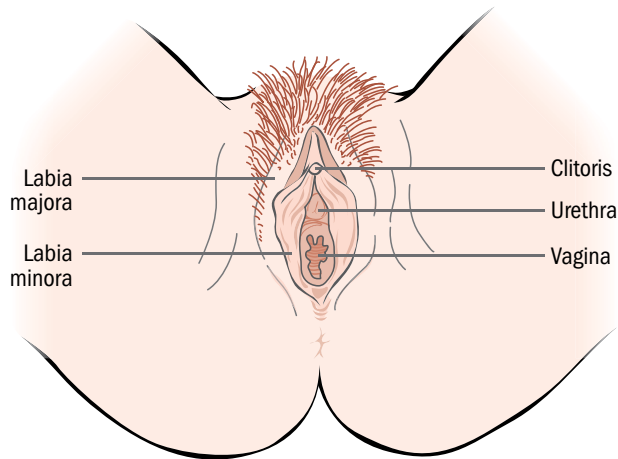

**Figure 14.5** Female sexual anatomy - frontal view.

The **hymen** is a thin membrane fold that partially closes the vaginal opening. A tear in the hymen can occur during the first experience of sexual intercourse or in a number of other ways.

The **labia majora**, or “lips,” are folds of skin that protect the opening to the vagina. They are covered with hair for added protection. The labia minora, also called “lips,” directly cover the opening to the vagina. They vary in color and size from woman to woman.

The **uterus** (womb) is a pear-shaped, thick-walled, hollow, muscular organ located in the lower pelvis. A fertilized egg will attach and grow in the uterus during pregnancy.

The **ovary** has the function of producing eggs and two types of hormones (estrogen and progesterone). Eggs are immature until puberty. At puberty, several eggs develop during each menstrual cycle. However, usually only one is released each month.

The **fallopian tubes** are the passageway between the ovary and the uterus. The egg travels down one of these passages. If intercourse occurs around the same time of the month that the egg is released by the ovary, a process called ovulation, the sperm will fertilize the egg.

Most women with spinal cord injury have few problems with sexual functioning. They have the physical ability to have intercourse and become pregnant. Decreased ability to move is usually the only limitation in the ability to perform sexually. However, sensation or absence of sensation can lead to physical damage of the genital

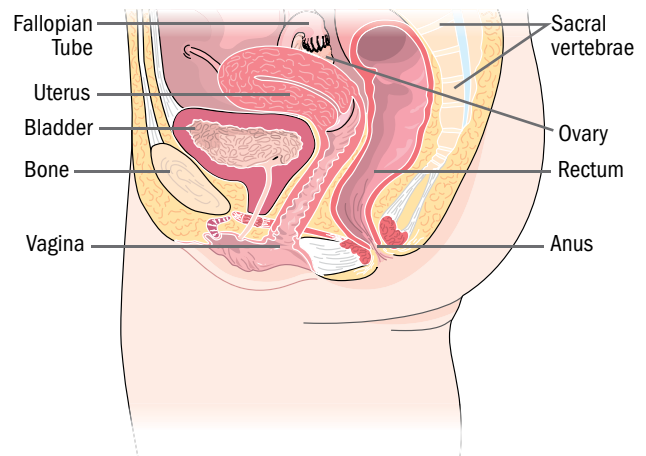

**Figure 14.6** Female sexual anatomy - side view.

area. A decrease in sensation, particularly around the genital area, may affect the orgasm experience.

Additional lubrication may be needed if the body does not provide enough natural lubrication. Remember: only use a water-soluble lubricant (e.g., K-Y Jelly, Replens<sup>®</sup>). Never use petroleum jelly such as Vaseline<sup>®</sup>, because it is oil-based and could cause an infection.

Menstruation (periods) may stop for a short time after spinal cord injury. It usually resumes within four to six months. Once it returns, most women are fertile again. If you do not want to get pregnant, you’ll have to use birth control. If you want to become pregnant, please discuss this with your doctor. Be sure to seek out an obstetrician-gynecologist who knows about spinal cord injury. An annual gynecological exam, including a Pap smear and breast exam, is still an important part of a woman’s health program, even after a spinal cord injury.

### BIRTH CONTROL METHODS

Several methods of varying effectiveness are available. You and your doctor should decide what methods of birth control are best for you. Effectiveness, side effects and practicality should enter into the decision.

You can choose several temporary methods: birth control pills, diaphragm, condom/foam combinations, cervical caps/sponges, an implanted device called Norplant<sup>®</sup>, which provides five years of birth control, or Depo-Provera<sup>®</sup>, an intramuscular injection that is administered every three months. A woman on birth control pills must monitor her blood pressure closely, especially if she is



prone to dysreflexia. Sterilization is a permanent option for women and men.

**PREGNANCY**

If a woman chooses to become pregnant, she needs to be aware that absent or decreased sensation can pose problems for labor and delivery. Autonomic dysreflexia is a factor in women with injuries at T6 or higher levels. There’s also an increased risk of bladder infection. Normal weight gain during pregnancy could cause difficulty with mobility and transfers. These problems, however, should not prevent a woman from having a baby. Most women with spinal cord injuries are able to go through labor, have vaginal deliveries and breastfeed their babies.

**SEXUAL ENJOYMENT**

Sexual enjoyment, or satisfaction, is not only physical but includes how one “feels” about one’s body. Knowing your body and willingness to learn new techniques are major factors in determining how well you will function

sexually. There are a variety of techniques and positions you can choose. Be creative, as long as both partners are comfortable and agree with the chosen activity. No one should ever feel forced or pressured into any activity. Intercourse is not the only way to share sexually. Kissing, touching, cuddling, massaging and fantasizing can also give you sexual pleasure. Create a mood by altering your environment with soft lighting, music, candles, etc. Experimenting with your partner is the best way to find out what feels good to you.

Lack of sensation or movement should not affect your desire for sexual pleasure for yourself or your partner. You can get to know your body even better than you did before your injury. Determine where you have sensation and if that sensation is pleasant. It may be in the genital area or in other parts of your body. Determine how your limitations with movement can be managed to provide the best opportunities for sexual expression.

Concerns	Recommendations
Fatigue (feeling tired)	<ul style="list-style-type: none"> <li>- Limit physical activity before sexual activity.</li> <li>- Try deep breathing or relaxation exercises before or during sexual activity.</li> <li>- Try engaging in sexual activity at different times of the day; identify that time of day when your energy level is at its highest.</li> <li>- Participate in a regular exercise program to increase your overall strength and endurance.</li> </ul>
Limited range of motion	<ul style="list-style-type: none"> <li>- Choose positions that have minimal range of motion demands (e.g., both partners in a side-lying position, facing each other).</li> <li>- Participate in a routine stretching program independent from sexual activity, or make it a part of sexual activity.</li> </ul>
Spasticity	<ul style="list-style-type: none"> <li>- Participate in gentle stretching exercises before sexual activity or make them a part of sexual activity.</li> <li>- Try a warm shower or bath before sexual activity or make it a part of sexual activity.</li> <li>- Try engaging in sexual activity at different times of the day.</li> <li>- Try to take advantage of spasms to achieve more movement during sexual activity; identify what positions or stimuli set the spasms off and utilize them.</li> <li>- Choose positions that decrease your spasms (e.g., sitting positions).</li> <li>- Talk to your physician about medication options.</li> </ul>
Adductor spasticity in women with SCI (which tends to cross the legs)	<ul style="list-style-type: none"> <li>- Alternative positions are an option.</li> </ul>

Concerns	Recommendations
Limited mobility	<ul style="list-style-type: none"> <li>- Combine transferring, disrobing and positioning with sexual activity.</li> <li>- Use a third person (e.g., attendant) for assistance with positioning.</li> <li>- Do exercises to increase your overall strength and mobility.</li> </ul>
High blood pressure associated with dysreflexia	<ul style="list-style-type: none"> <li>- Identify the activity or other causes of the dysreflexia (e.g., genital stimulation, excessive stretch of hamstrings); stop that specific activity or discontinue the stimulus and change to something else.</li> </ul>
Increased risk of skin breakdown on bony and weight-bearing areas	<ul style="list-style-type: none"> <li>- Use appropriate padding if needed.</li> <li>- Choose positions that provide the least amount of pressure on the bony areas at risk.</li> <li>- Check your skin frequently.</li> </ul>
Friction caused by catheter or adaptive devices	<ul style="list-style-type: none"> <li>- Use a water soluble lubricant, such as KY Jelly.</li> <li>- Tape the catheter tubing out of the way (Males: tape tubing to the penis and/or use a condom to hold it in place; females: tape the tubing to the abdomen or inner thigh).</li> </ul>
Obesity	<ul style="list-style-type: none"> <li>- Choose positions that avoid placing the heavier person's weight on top of partner (e.g., side-lying positions are an option).</li> </ul>

The ability to achieve orgasm is dependent on the level of your injury. If S2, 3 or 4 levels are intact, you can feel sexual pleasure in your genitals. If you have a complete injury above S2, 3 or 4, you will feel warmth and pleasure above the level of your injury. There are other ways a person with spinal cord injury can feel satisfied. There may be tingling in the lower extremities, increased heart rate and a sense of pleasure and intense relaxation. These are usually the same ways able-bodied persons describe orgasm.

Many people with spinal cord injury say they still enjoy sex and that it's an important part of their lifestyle. Some say they can have orgasm-like feelings similar to those experienced before injury, although there is no guarantee that everyone will be able to have an orgasm after spinal cord injury.

### GETTING READY FOR SEXUAL ACTIVITY

Sex may not be as spontaneous as it was before your injury, but planning for it can be fun. There are some things that need to be considered and communicated with your partner.

**Cleanliness.** Both partners should wash their genitals if they cannot have a complete bath. Body oils and secretions carry bacteria.

**Bladder control.** If bladder control is a problem, plan ahead. Reduce your fluid intake several hours before sex. Empty your bladder just before sex by your usual method. Remember, alcohol increases the urine output so avoid using alcoholic beverages to help you "relax." If you use an indwelling catheter, follow these easy steps:  
*Males:* Fold the catheter tubing back over the penis and put a condom over it to keep it in place.

*Females:* Tape the catheter tubing to the inner thigh. Urinary "accidents" can occur when pressure is applied over the bladder. If the able-bodied partner is in the dominant position (on top), pressure could cause bladder spasms or leaking.

**Bowel control.** This is another aspect that needs to be planned ahead of time. Do not plan to have sex less than two hours before your bowel program is scheduled because pressure can stimulate the bowels to move. Again, do not let all the preparation get in the way of your pleasure. Plan ahead and be prepared.

### **MOVEMENT AND POSITIONS**

Paralysis below the level of injury may affect the ability to carry out certain sexual motions. It's important to know that sex can be enjoyed even with loss of movement and sensation. If assistance is needed with transfer, plan the position before the transfer occurs. Deciding how and where to have sex can actually be part of the foreplay.

Remember, knowing what turns you on and sharing this information with your partner are important parts of experiencing your sexuality. This is quite true when it comes to sexual positions. Consider the use of pillows to provide the best angle or to provide a cushion for bony areas.

A handout available in the RAPS Class on Sexuality shows different positioning options for males and females with SCI. You can also obtain this handout from your social worker or therapist.

The following section is a list of concerns that may affect sexual positions, options and techniques, along with some recommendations for solutions.

### **SAFE SEX CONSIDERATIONS**

Anyone can get sexually transmitted diseases (STDs). Use a condom to protect yourself and your partner. Condoms help block the spread of infection. Limiting the number of sexual partners you have will also reduce your risk. Research shows that people with only one partner greatly reduce their chances of getting a STD. Several STDs can be contracted by persons who are sexually active, including chlamydia, genital warts, herpes, gonorrhea, syphilis and HIV/AIDS.

Consult your doctor if you notice any unusual discharge, skin irritation, rashes, foul odor or swelling in or around your genitals.

### **MEDICATIONS THAT MAY ALTER SEXUAL RESPONSE**

A change in sexual function can be caused by physical or emotional factors, or a combination of both. Medications may also produce side effects that can lead to sexual dysfunction. Some medications may affect sexual desire and the ability to become physically aroused; others may delay orgasm or produce pain during intercourse. The following medications have been associated with altered sexual function. Consult your physician or pharmacist if you have questions.

#### **Medications Used to Treat High Blood Pressure**

- Alpha adrenergic blockers
- Beta blockers
- Calcium channel blockers
- Centrally acting agents
- Diuretics

#### **Medications Used to Treat Depression**

- Tricyclic antidepressants
- Selective serotonin reuptake inhibitors (SSRIs)
- Various others

#### **Medications Used to Treat Psychotic Disorders**

- Lithium carbonate
- Thioridazine
- Thiothixene

#### **Substances of Abuse**

- Alcohol
- Cocaine
- Marijuana

**SUMMARY**

Sexuality and sexual functioning are important to everyone. Most people have an interest in sexuality regardless of their disease or disability. Sexual activity is the result of personal choices made by two consenting people. Be aware of your own sexuality and your own sexual preferences.

If you remember these simple facts you can provide pleasure for both yourself and your partner.

**Sexual desire is still there** after a spinal cord injury.

**You can still please and be pleased** despite loss or lack of movement.

**You can still have sexual feelings** even with loss or lack of sensation.

**You still have your own sexuality** even with loss of genital function.

**ATTENDANT CARE****Highlights**

- The process of establishing a plan for attendant care includes:
  1. Develop a checklist of your personal care needs.
  2. Determine the type and amount of personal care assistance needed.
  3. Assess the available resources for payment.
- Always have a back-up plan for attendant care.

Many people with a severe disability cannot live on their own without physical assistance provided by a personal care attendant (PCA). For this reason, finding and keeping a PCA becomes the key to independent living.

What are personal care attendants (PCAs) and how are they different from nurses or nurses' aides? PCAs are people you hire to assist you with your day-to-day activities. Unlike nurses, PCAs are not licensed and take directions for your care from you. PCAs depend on your input to help them do their job the way you want it done.

**Needs and Resources**

1. Develop a checklist of your personal care needs.
2. Determine the type and amount of personal care assistance needed.
3. Assess the available resources for payment.

Be creative in matching your needs and resources. Assess how you might incorporate your family's assistance with that of paid caregivers to prevent family burnout. Work with your team members to simplify your home care.

If you decide to hire an attendant, determine how you'll proceed with your hiring process. Word of mouth is usually the best way to locate an attendant but you may also decide to advertise in local newspapers or newsletters. State your requirements simply, such as:

**WANTED:** Female to assist in personal care activities of physically disabled adult; full-time; light housekeeping required. Salary: \$170/week. Call Jim at 000-0000.

Possible places to post your advertisement include:

- City newspapers
- College newspapers
- College employment offices
- Neighborhood newspapers or newsletters
- Church bulletins
- Employment agencies
- College dormitory bulletin boards
- Library bulletin boards
- Supermarket bulletin boards
- Minority interest publications
- YMCA or YWCA bulletin boards
- Vocational rehabilitation agencies
- Hospital bulletin boards
- Organizations that provide services to people with a disability
- Consumer organizations for people with a disability

Talk to friends, neighbors, co-workers, relatives, medical personnel, social workers, other attendants and other people who already have attendants.

**Interviewing**

Meet face-to-face with a potential PCA. You'll need to determine whether you'll be able to work together. The interview allows you to:

- Get an idea of the candidate's skill through responses to your questions and/or demonstration.
- Review the job description. You may want to use the checklist you initially made to determine your personal care needs.
- Assess the candidate's personality and consider how well you'll be able to work together.

The candidate should complete an application form, including references. Through the interviewing process you can check the information recorded on the application. Questions on the application form might include the candidate's previous work experience, health record, personal beliefs, type of transportation, driving record and references.

The following is a list of important topics to cover when interviewing an applicant:

- Previous work record
- Personal history, driving record, health record and drug or alcohol problems
- Modes of transportation



- Job tasks in detail
- Hours, rate of pay, time off and weekend responsibilities

Be sure to ask open-ended questions and check the applicant's references.

### **Training**

Use the job description as a training tool. Be clear with your instructions and remember that we all learn in different ways.

### **The Relationship Between You and Your Attendant**

It's important that you recognize your role as the employer, and your responsibility to be clear in your expectations and communication. If a family member is your attendant, then clear communication becomes essential, as family roles have most likely been altered by the necessity of providing for your personal care needs. You must learn to be assertive (clearly state your needs while recognizing the needs of others) but not aggressive (disregarding the needs of others for your own purpose) or passive (relinquishing your needs to others).

Substance abuse by either you or your attendant will compromise your care. Be vigilant to prevent this from becoming a problem.

### **Back-Up System**

It's a common mistake to depend solely on one or two attendants. This does not provide a back-up plan when your attendant has an emergency such as illness or car, family or weather problems.

Always have a back-up plan for getting the personal care you need. You may even want to have a plan in writing. A good back-up system ensures that you'll be able to remain in control of the situation.

Most communities offer several sources of temporary back-up help. In large cities, home health agencies are a prime resource for nurses' aides or licensed vocational nurses (LVNs). These services can be expensive, but help is usually available on short notice. It's a good idea to keep a list of names and telephone numbers of reliable people with the times they are available. Some people with a disability call the people on their list "just to chat." This maintains a friendly contact and allows you to make sure their schedules have not changed.

There are several informal and often less expensive back-up systems besides home health agencies. These include family or nearby relatives, friends, neighbors or previous attendants. Your attendant might even be willing to find his/her own substitute. It's worth asking!

### **Dealing with Problems with Your Attendant**

Terminating an employee is rarely a pleasant experience. There can be many reasons for terminating an attendant, including not being able to follow instructions, routinely being late or not showing up for work at all.

When you're considering terminating an attendant, discuss your concerns with the employee. Be specific and suggest ways for improvement. Ask for their suggestions and give a specific timeframe for correcting the problem.

To help avoid misunderstandings in what you expect of an attendant, it's a good idea to write up a contract. Both you and your PCA should sign the contract and keep a copy. The contract helps clarify what you expect of an attendant. Many people choose not to have a formal, written contract. Instead, they rely on good communication to make their needs known. You will need to decide which style fits you best. However, it's often helpful to have a written agreement to back up your reasons for firing someone.

### **If You Must Terminate Your Attendant**

If terminating your attendant is the best solution, try using phrases such as: "This arrangement is not working out as I had hoped. I feel that I need to find someone more compatible with my lifestyle and needs." The attendant should be given one to two weeks notice prior to his/her last day on the job. This period may be shorter if the reason for firing is an intolerable problem.

If you're in doubt about whether to terminate your attendant, consider this rule of thumb: If your attendant is frequently interfering with or hindering your daily activities, then think about finding someone else more compatible. Having an attendant enables you to live an independent life. If your attendant is not helping you to reach this goal, he or she has become another disability.

## TRANSPORTATION AND DRIVING

### Highlights

- Disabled parking privileges enable an individual with a mobility impairment to park in specially marked parking spaces when the driver or passenger is disabled.
- At some point in your rehabilitation, you may have a comprehensive driving evaluation, which will measure reaction time, visual skills, coordination, strength, endurance, trunk balance, visual perception and knowledge of driving rules.
- It's important to use a reputable dealer who has a history of reliability to install your driving equipment.

Disabled parking privileges are available for individuals with mobility impairment. The disabled parking spaces can only be used if you have a plastic placard or a license plate with a disability emblem. The placard is hung from the rearview mirror inside the vehicle. It can be used only if the driver or passenger is disabled. Application to obtain the placard or license plate is provided by your County Tax Assessor's office.

Refueling services for disabled drivers enable those who possess a valid disabled license plate or placard to receive self-service prices at full-service pumps.

The purchase of a modified vehicle, or a vehicle that will be modified shortly after purchase, to transport or be driven by someone with an orthopedic disability is exempt from tax. Also, no tax is due on adaptive devices, labor to install those devices or remodeling costs on the vehicle to accommodate the disabled person. For more information, contact the State Comptroller's Office toll free at 1.800.252.5555.

Alternate transportation resources may be available, specific to your city or state. For example, the City of Houston provides a door-to-door transportation service for eligible persons in the service area following completion of the application process:

Metro Lift  
Customer Service  
713.225.0119

All City of Houston buses are now equipped with lifts. Check with your city or county for accessible transportation services. Many cities also offer private wheelchair-accessible vans for rent. Check with your TIRR

Memorial Hermann social worker or contact a hospital in your area that provides services to persons with a disability.

### DRIVING

- The doctor treating you for your spinal cord injury must refer you to the driving program.
- You must have passed the written driving test and have a learner's permit or a valid driver's license. A verification procedure conducted with the Department of Public Safety in your state will ascertain if there are any outstanding tickets or warrants on your license.
- Even before you get behind the wheel, your physical strength, coordination, vision and perception, cognitive ability and reaction time will be evaluated.
- The next step in the evaluation checks your ability to transfer into the vehicle and, if necessary, load the wheelchair into the vehicle after you have transferred from it.
- The behind-the-wheel (in-vehicle) evaluation is conducted in the adapted vehicle on a protected parking lot. You'll have the opportunity to use adaptive controls wherever these are needed. Steering, braking and acceleration controls will be observed and tested. If you're able to conduct each of the driving tasks safely in the parking lot, you'll move on to residential streets or busier city streets.
- The driving evaluator will determine approximately how much training you will need before you're ready to go to the Department of Public Safety for a driving test.

### Driving Evaluation, Training and Equipment for People with Paraplegia

If your injury resulted in paraplegia, you will probably have only mild or moderate difficulty transferring into a car. You may need the help of a transfer board during the transfer.

Once you're in the vehicle, the next step is to load your wheelchair. Your options are to load the wheelchair into the back seat if your vehicle has two doors, or in the front seat on the passenger's side. Some people with paraplegia do not have enough arm strength or trunk control to load a wheelchair, and may decide to use a wheelchair-loading device (car topper). Others find it best to use a van with a lift to save their strength and endurance for driving.

On either type of vehicle, the driving controls might include hand controls, a steering device, an emergency brake extension and a turn-signal extension. These controls easily fit most vehicles without interfering with regular controls.

### **Driving Evaluation, Training and Equipment for People with Tetraplegia**

People who have had an injury resulting in tetraplegia but have regained considerable upper-body strength may be able to:

- Transfer in and out of the vehicle
- Learn to compensate for loss of trunk balance enough to be able to drive a car sitting in a regular car seat instead of a wheelchair

Typically, however, the majority of people with tetraplegia will need to sit in a wheelchair to drive and will require a modified vehicle. Equipment for driving the van may be similar to the modified hand controls in a car, or may need to be more specialized to compensate for weakness and limited range of motion. The hand controls may have a vacuum-assist system or be set in a different plane or angle to compensate for a lack of range of motion and/or decreased hand strength. Since a steering wheel or steering knob is usually hard to grasp, other options for steering are offered such as a tri-pen or spinner yoke.

The controls for steering and brake/gas can be modified, as can the controls that operate turn signals, windshield wipers, lights, horn, the air/heat control system and the lift operation. The modifications might utilize flip switches or extended knobs.

The tie-down and driver restraint systems are very important. The tie-down system is usually electronic and automatic and the restraint system often is either a passive restraint or a combination of passive and active restraints.

### **Vehicle Safety**

Choose a reputable dealer with a history of reliability to install your driving equipment. There are standards in some states that regulate the installation of all equipment as well as the modification to vehicle structures. Be sure to check with the vocational rehabilitation department in your state or with the Association of Driver Educators for the Disabled (ADED). The address for ADED is:

ADED  
711 S. Vienna Street  
Ruston, LA 71270  
318.257.5055; 1.800.290.2344

Don't take any chances with modifications, since your safety and the safety of your loved ones and others on the road depend on how well the modifications have been made.

If you'll be riding as a passenger in your vehicle from time to time, you'll also need to be sure that the passenger seat or area has an appropriate restraint system. When you're in a car, the standard seat belt and chest restraint should protect you. If you have poor trunk control, a chest restraint will provide extra stabilization to prevent you from sliding from side to side. If you're riding in your wheelchair in a van, you'll need to ride facing forward. Your wheelchair should have the appropriate four-point tie-down with an attached chest restraint.

You should also be aware of how the medications you take can affect your driving safety. For instance, the medication you take to reduce spasticity may help you control your driving movements but can also make you drowsy.

### **Equipment Options**

If you're able to transfer into a vehicle independently, you should be aware that some car designs are easier for transfer than others:

- A two-door sedan has larger openings for the front doors, allowing you to get closer to the car seat when transferring.
- A split-bench seat allows you to transfer in from either side and slide across and to load the wheelchair either behind you or in the front seat on the passenger side.
- Full-sized vans accommodate a broader variety of people than minivans. However, minivans are an option if you meet certain criteria, such as transfer ability, size of wheelchair and your overall height in the wheelchair.
- Full-sized vans accommodate people who can transfer into a driver's six-way power seat or must remain in their wheelchair for driving. These vans have more interior space for a driver in a wheelchair and passengers who remain in their wheelchairs.

Be sure that whatever vehicle you choose can be outfitted specifically for you. Some people buy used vehicles with

adaptive controls already installed. If you do this, be very sure that a reputable adaptive mobility installer checks out the vehicle and the equipment before you make a final decision to ensure that the equipment meets all your safety, mobility and functional needs.

## RECREATION AND LEISURE

### Highlights

- Recreation and leisure are essential to keeping a healthy, balanced lifestyle.
- Remaining active after a spinal cord injury reduces the risks of skin breakdown, joint tightness, muscle atrophy, respiratory problems and other medical complications.

Recreation and leisure are an essential part of keeping a healthy, balanced lifestyle for all persons. Recreation means “restoration or recovery.” It’s helpful in restoring your mind, spirit and body. Leisure, which comes from a Latin word that means “to be free,” includes activities you choose to do just for the fun of it. Recreation and leisure activities are individual for each of us. They may include sports, picnics, family time, repairing cars, socializing with friends, hunting, bowling, swimming or reading a book.

Having a spinal cord injury is no reason to cut down on or stop your recreational activities. It’s just as important now to keep a healthy, balanced lifestyle. Remaining active reduces your risks of skin breakdown, joint tightness, muscle atrophy, respiratory problems and other medical complications.

Your injury should not stop you from joining in a large number of recreational opportunities. While you’re in rehabilitation, a **certified therapeutic recreation specialist (CTRS)** or other team member may talk to you about your recreation and leisure interests. They may teach you how to use different kinds of adaptive recreation equipment that can be purchased from catalogs or vendors. Many people with a spinal cord injury choose to make their own equipment. The use of adaptive equipment has enabled persons with paraplegia and tetraplegia to join in sports such as snow skiing, water skiing, tennis, basketball, softball, football, quad rugby, archery, bowling and hunting.

While in rehabilitation, your treatment team may recommend that you participate in community outings with other persons with spinal cord injury. These community outings will give you the chance to work on your rehabilitation goals in a non-hospital setting.

Outings may teach you skills to help you identify and manage architectural barriers, deal with the public and recognize problem areas to work on before returning to your home. These outings also give you the chance to get out of the rehabilitation setting for a while and just have fun. You may even discover a new leisure option that you would like to pursue after rehabilitation.

Many groups in your community can help you further develop your leisure interests. They include:

- Local parks and recreation departments
- The Chamber of Commerce
- Service organizations such as YMCA, YWCA, churches and the Red Cross
- Sports associations or groups formed by people with disabilities who have common interests or needs

**HIGHLIGHTS**

- The Americans with Disabilities Act (ADA) provides civil rights protection to individuals with disabilities.
- ADA Technical Assistance Centers provide information about the specifics of the ADA legislation and training to support implementation of the ADA.

As a person with a disability, you should be aware of the laws that prohibit discrimination against you in employment and education, as well as access to transportation, local and national governmental services and certain services when you visit places that serve the public, known in legal terms as “public accommodations.” The definition “public accommodations” includes hotels, restaurants, theaters, hospitals and professional offices such as lawyers’ or doctors’ offices.

This section will describe some of these laws starting with the most far-reaching law, the Americans with Disabilities Act (ADA). A general knowledge of the law will serve you well when you advocate for your own rights.

This section will describe each law (or section of the law) in the following manner:

- **WHERE** the law applies
- **WHAT** the law entitles you to
- **HOW** to file complaints

**THE AMERICANS WITH DISABILITIES ACT (ADA) OF 1990**

This is the most important civil rights law passed in decades; it covers more situations than any other disability-related law in effect. It makes discrimination against persons with a disability illegal in certain public and private places and in the performance of certain activities.

The ADA and its coverage are easier to understand if the law is broken down into sections labeled: Titles I, II, III and IV.

**Title I (of the ADA) – Employment**

**WHERE** the law applies:

After July 26, 1994, the law applies to employers with 15 or more employees.

**WHAT** the law entitles you to:

The law forbids discrimination in all aspects of employment against “otherwise qualified” people with disabilities. Employers must make reasonable modifications in the workplace for employees with disabilities who need the modifications to perform the essential functions of the job, unless doing so would create an undue hardship or difficulty for the employer. It is the responsibility of the employee to let the employer know that a modification is needed to enable the individual to perform the job.

**HOW** to file complaints:

The Equal Employment Opportunity Commission (EEOC) is the enforcing agency. Complaints generally must be filed with them within 180 days of the discriminatory act.

EEOC questions may be directed toll free to:

**1.800.669.3362 voice**

**1.800.800.3302 TDD**

**Title II (of the ADA) – State and Local Service, Government Programs and Activities**

**WHERE** the law applies:

This law applies to state and local government entities (offices, programs or agencies); it went into effect on January 26, 1992.

**WHAT** the law entitles you to:

The law forbids discrimination on the basis of disability in the employment practices, programs and services of state or local governmental entities. Public employers must also make reasonable modifications to adapt the workplace. This includes access to any transportation services provided by or for any governmental entity. Structural changes may also have to be made to existing governmental property where necessary to provide access to programs or services.

**HOW** to file complaints:

Complaints may be submitted in a number of ways. You may file suit or complain to any of the agencies appointed as enforcers of this law (see agencies listed later in this chapter). When in doubt, file with the Department of Justice. A letter describing the act of discrimination, the date it



occurred and the name and address should be sent to:  
 U.S. Department of Justice  
 Civil Rights Division  
 Coordination and Review Section  
 P. O. Box 66118  
 Washington, DC 20035-6118

### **Title III (of the ADA) – Public Accommodations and Commercial Facilities**

**WHERE** the law applies:

It forbids discrimination based on disability in public accommodations. Public accommodations include hotels, restaurants, theaters, hospitals and professional offices such as lawyers' or doctors' offices. Also covered are any transportation services provided by any place that could be called a public accommodation.

**WHAT** the law entitles you to:

The public accommodations described above must remove communication and architectural barriers from their existing physical setup (buildings, grounds, etc.), where such removal can be accomplished without much difficulty or expense. Examples of easily accomplished barrier removal include installing ramps, moving display racks in stores and making signage accessible for those who are visually impaired or blind.

Public accommodations must also provide a way for people with visual or hearing impairments to communicate effectively so they can receive the services or information provided by the public accommodation. This means that doctors, attorneys and any similar organizations or offices that serve the public may need to provide interpreters for their clients and patients who are deaf if this is the only way the information can be communicated effectively. Restaurants, retail stores and other similar places that are open to serve the public must also make sure that people who are deaf are provided with a way to communicate when using the services of the establishment, such as a note pad and pencil.

**HOW** to file complaints:

If you believe your rights have been violated, you may file a complaint with the Department of Justice. Send a letter describing the act of discrimination, the date it occurred and the name of the organization that discriminated against you, along with your full name and address to:

U.S. Department of Justice  
 Civil Rights Division  
 Coordination and Review Section  
 P. O. Box 66118  
 Washington, DC 20035-6118

### **Title IV (of the ADA) – Telecommunications**

**WHERE** the law applies:

Companies offering telephone services to the general public.

**WHAT** the law entitles you to:

Companies offering telephone services to the general public must offer telephone relay services to people who use telecommunications devices for the deaf. The services provided must be equal in quality and availability to those provided everyone else.

Contact your state's telecommunications carrier to see who is providing this service in your state (Relay Texas may be reached toll free at 1.800.735.2989.)

**HOW** to file complaints:

Complaints should be sent to:  
 Federal Communications Commission  
 1919 M Street, NW  
 Washington, DC 20554

### **Title V (of the ADA) – Miscellaneous**

**WHERE** the law applies:

This law states the ADA takes precedence over any inconsistent state or local laws. In other words, the ADA governs where it is more stringent, but where the state or local law is more stringent, that will be the standard.

Information and assistance in understanding the ADA may be obtained by calling 1.800.949.4232. The number will connect you to the ADA Technical Assistance Center serving your area. ADA Technical Assistance Centers provide information on most of the laws dealing with disability rights; training on implementation of the Act; technical assistance with specific questions; and referrals for additional specialized information.

### **Section 504 of The Rehabilitation Act of 1973**

**WHERE** the law applies:

Any program or activity receiving federal financial assistance.

**WHAT** the law entitles you to:

Federally assisted programs and activities such as education, health or welfare services are forbidden to practice discrimination based on a person's disability. Access to employment and the facilities (physical location or programs) are also covered in this law.

**HOW** to file complaints:

You can file suit directly in court or file a complaint with the Offices of Civil Rights of the federal executive agencies that fund the program. The agencies are:

**Department of Agriculture:** All programs, services and regulatory activities relating to farming and the raising of livestock, including extension services. Complaints should be sent to:

Complaints Adjudication Division  
Office of Advocacy and Enterprise  
Department of Agriculture  
Room 1353 – South Building  
14<sup>th</sup> & Independence Avenue, SW  
Washington, DC 20250

**Department of Education:** All programs, services and regulatory activities relating to the operation of elementary and secondary education systems and institutions, institutions of higher education, libraries and vocational schools (other than schools of medicine, dentistry, nursing and other health-related schools).

Complaints should be sent to:

Office of Civil Rights  
Department of Education  
330 C Street, SW, Suite 5000  
Washington, D.C. 20202

**Department of Health and Human Services:** All programs, services and regulatory activities relating to the provision of healthcare and social services, including schools of medicine, dentistry, nursing and other health-related schools, the operation of healthcare and social services providers and institutions (including community services organizations and programs, and preschool and day care programs). Complaints should be sent to:

Office of Civil Rights  
Department of Health & Human Services  
330 Independence Avenue, SW  
Washington, DC 20201

**Department of Housing and Urban Development:** All programs, services and regulatory activities relating to state and local public housing, and housing assistance and referral. Complaints should be sent to:

Assistant Secretary for Fair Housing and Equal Opportunity  
Department of Housing and Urban Development  
451 7<sup>th</sup> Street, SW – Room 5100  
Washington, DC 20410

**Department of the Interior:** All programs, services and regulatory activities relating to lands and natural resources, including parks and recreation, water and waste management, environmental protection, energy, historic and cultural preservation, and museums.

Complaints should be sent to:

Office for Equal Opportunity  
Office of the Secretary  
Department of the Interior  
18<sup>th</sup> & C Streets, NW  
Washington, DC 20547

**Department of Justice:** All programs, services and regulatory activities relating to law enforcement, public safety and the administration of justice, including courts and correctional institutions; commerce and industry, including general economic development, banking and finance, consumer protection, insurance and small business; planning, development and regulation (unless assigned to other designated agencies); state and local government support services, including audit, personnel, comptroller and administrative services; and all other government functions not assigned to other designated agencies. Complaints should be sent to:

Coordination and Review Section  
Civil Rights Division  
U.S. Department of Justice  
P. O. Box 66118  
Washington, DC 20035-6118

**Department of Labor:** All programs, services and regulatory activities relating to labor and the work force. Complaints should be sent to:

Directorate of Civil Rights  
Department of Labor  
200 Constitution Avenue, NW, Room N-4123  
Washington, DC 20210

**Department of Transportation:** All programs, services and regulatory activities relating to transportation, including highways, public transportation; traffic management (non-law enforcement); automobile licensing and inspection; and driver licensing. Complaints should be sent to:

Office for Civil Rights  
Office of the Secretary  
Department of Transportation  
400 Seventh Street, SW, Room 10215  
Washington, DC 20590

Complaints involving more than one area should be filed with the Department of Justice. If two or more agencies are the designated agency for your complaint, the Assistant Attorney General for Civil Rights of the Department of Justice will determine which agency will be the designated agency for the complaint. Complaints involving more than one area of a public entity should be sent to:

Coordination and Review Section  
Civil Rights Division  
U.S. Department of Justice  
P. O. Box 66118  
Washington, DC 20035-6118

**FAIR HOUSING ACT**

**WHERE** the law applies:

All public and private real estate transactions, including any aspect of a rental agreement.

**WHAT** the law entitles you to:

This law forbids discrimination based on disability, race, color, sex, religion or national origin in the above situations. Landlords must allow tenants to make reasonable changes to existing premises at the tenant's expense. Apartment buildings designed for first occupancy after March 13, 1991, must be constructed so they are accessible to people with disabilities according to certain technical guidelines.

**HOW** to file complaints:

You may file suit directly or file a complaint with:  
Department of Housing and Urban Development  
451 7<sup>th</sup> Street, SW, Room 5100  
Washington, DC 20410

**HIGHLIGHTS**

- Before your discharge from TIRR Memorial Hermann, choose a family doctor or primary care physician (PCP) and have copies of your medical records sent to his or her office.
- You will receive prescriptions for your medications, but it is your responsibility to have the prescriptions filled upon discharge.
- Good health habits and regular check-ups are critical to preventing and minimizing medical complications. Be especially alert to your respiratory system, nutrition, skin and urinary system.
- To use your healthcare insurance, you must have a thorough knowledge about your own healthcare needs and learn everything you can about your healthcare plans.

**PREPARING TO LEAVE TIRR MEMORIAL HERMANN**

Before discharge from TIRR Memorial Hermann, choose a family doctor or personal care physician (PCP). This doctor needs to know about you while you are in good health in order to recognize any changes in your health or problems that may need to be treated.

Once you have identified a family doctor/PCP, give the name and address to the TIRR Memorial Hermann staff so they can complete a Release of Medical Information form to send copies of your medical record to this doctor's office. This enables your family doctor to know your medical history and what care you received while you were in rehabilitation.

Please make an appointment to see your family doctor/PCP as soon as possible after discharge from TIRR Memorial Hermann. Your health plan may require that you obtain referrals from your PCP for any continued services, such as outpatient therapy. Your TIRR Memorial Hermann physician cannot provide routine medical care for you.

Know the location of a hospital emergency room near your home in case you develop a problem that needs immediate attention. If you need a hospital and do not know which one fits your needs, ask the case manager or outpatient clinic nurse before an emergency occurs.

**ORDERING MEDICATIONS**

Most patients who leave our hospital receive prescriptions for medications. Please have these filled at a pharmacy designated by your health plan. The TIRR Memorial Hermann pharmacy cannot fill prescriptions for discharge medications, or provide an initial supply of medications.

If you reside out of town, ask your case manager to fax copies of your prescriptions to your local pharmacy so that they will be ready for pick-up when you arrive home. Be sure to make this request several days prior to discharge and have the name and phone number of your pharmacy available.

**It is your responsibility** to have your medications refilled before you run out, so that your treatment will not be interrupted. If your medication requires a written prescription, contact your doctor's office seven days prior to when you need it to allow mailing time.

Medications can be obtained directly from your local pharmacy. Call your pharmacy at least one working day before you need your refills. It is best to go to one pharmacy for all of your prescriptions. Always include your name and the prescription number with your request.

If you are an adult using Medicaid, you are eligible for three prescriptions a month. You must present the Medicaid authorization voucher when you pick up your medicine.

If you receive assistance from your local rehabilitation commission, you may have to contact your counselor before ordering your medication and supplies. Check the rules in your area.

**CAUTION:** Medications are expensive. Inform your doctor if you think a medicine is not working or has undesirable side effects. **DO NOT stop taking a medicine without talking with your doctor first.** Some medications need to be discontinued slowly to prevent problems that may occur from suddenly stopping them.

Periodic visits to your doctor are recommended to maintain your health. Many doctors will not refill medications or reorder supplies if they have not seen you during the previous year, since they will be unaware of any changes that may have occurred in your health condition.

## ORDERING SUPPLIES

Because we do not issue supplies to you at time of discharge, you'll need to obtain them the same way you obtain your prescription medications. In time, you'll learn the amount of supplies you need to keep on hand to avoid running out. Medical supplies may be purchased from discount stores, medical supply stores and pharmacies. Some pharmacies will order the supplies for you if they do not have them in stock. Your case manager can assist you in locating a provider and in obtaining a prescription from your physician, if needed.

Ordering medical supplies by mail is often the most economical and convenient way to purchase. However, if you're ordering supplies through the mail, allow two weeks for delivery. You may have to pay in advance or have an approval from your health plan to be billed directly. Always provide the name and policy number of your insurance when ordering.

Supplies can be expensive. To prevent waste, use your supplies only when you need them. If you use your supplies properly, some can be reused, such as leg bags and bedside bags. Items purchased that are related to your disability are tax deductible. Save all your receipts for income tax purposes.

## MAINTAINING YOUR HEALTH

Healthy habits prevent many medical problems and may improve the quality and duration of your life. When you have a spinal cord injury, good health habits and regular checkups are critical to preventing and minimizing medical complications. You must be especially alert to your respiratory system, nutrition, skin and urinary system. Each of these areas has been thoroughly discussed in the previous chapters, but as a reminder:

**Respiratory System.** With a spinal cord injury, your cough mechanism has been weakened, making it impossible to clear secretions from your lungs as effectively as before your injury. Buildup of secretions will cause infection. You must practice excellent pulmonary hygiene (including suctioning, not smoking, strengthening exercises for respiratory muscles, assist cough, etc.). Get prompt medical help if you develop a cough, fever, chest pain or shortness of breath.

**Nutrition and Skin.** Nutrition and skin care work hand in hand. A balanced diet, appropriate amounts of water

and avoidance of smoking, alcohol and harmful drugs, all contribute to proper nutrition and healthy skin. In addition, you can prevent development of pressure sores by routine weight shifts, keeping your skin clean and dry and avoiding trauma to your skin. Examine your skin twice a day for changes in color and texture. Make certain that your wheelchair cushions are adequate and not in need of repair. Consult your physician when you develop unexplained or severe weight loss. Also, see your physician when reddened areas develop or recur in the same place.

**Urinary System.** Because you cannot easily tell when a problem is developing, caring for your urinary system is the most important area of healthcare maintenance. If you use a catheter, it can be the entry point for germs to enter the bladder or migrate to the kidneys. Repeated infections can lead to kidney stones. Urine can also be retained in the bladder causing such complications as autonomic dysreflexia or reflux of urine. It's important to follow the urinary management program recommended for you and to have routine check-ups.

## Bowel System

### Regular Check-Ups

You may not have symptoms from some health problems, such as urinary tract infections. With regular checkups, you can detect problems while they are still manageable and avoid complications.

Be sure to schedule regular follow-up visits to your outpatient clinic or doctor, using this timetable:

- Every six months for the first two years post-injury
- Annually for three to five years post-injury
- Every two years after five years, depending on your individual needs, or whenever you find a problem that you cannot resolve

Your follow-up care may include yearly renal ultrasounds, chest and spine X-rays, etc. Be alert to complications that may occur over time. See your doctor if you experience skin breakdown, increased spasms, lessened sensation or muscle strength, an unmanageable bowel program, frequent recurrences of urinary tract infections or sudden onset of pain.

Remember that you are also susceptible to all the same diseases and medical conditions as people without an SCI, particularly as you grow older. They include:



hypertension, heart disease, diabetes, stroke and cancer, particularly of the breast and prostate. Your checkups should include routine screening for these health conditions, too.

Do not forget preventive immunizations, such as shots for flu, pneumonia and hepatitis.

**IN CASE OF EMERGENCY**

The following are examples of emergency situations:

- Burns
- Difficulty breathing
- Drug overdose
- A severe allergic reaction
- Blood in your urine
- Dysreflexia of unknown cause
- A temperature above 101 degrees Fahrenheit
- Broken bone
- Severe stomach pain
- Convulsions

If you do have to go to an emergency room, remember to take along a list of all medications you're currently taking and any treatments you are undergoing. List all non-prescription or over-the-counter drugs that you're taking. Also be sure to take your insurance information.

Prior to your discharge from TIRR Memorial Hermann you will receive a small laminated card identifying the signs, symptoms and treatments for autonomic dysreflexia. You should carry this with you at all times so that it can be used by you, others or emergency personnel if a medical emergency occurs.

**MAINTAINING "HEALTHY" EQUIPMENT**

Equipment is continually being improved and perfected. Changes in equipment may improve your health or function. Defective or old equipment may be the cause of skin breakdown and overused muscles or joints. Be sure your wheelchair cushions are in good condition and not worn or torn. Poorly fitting braces or crutches may also cause skin breakdown or a loss of sensation or function.

**HIGHLIGHTS**

- Many financial resources may be available to you, including Social Security Disability Income, Medicare, Medicaid and Supplemental Security Income.
- The Division of Assistive Rehabilitation Services (DARS) has three programs available for individuals with spinal cord injuries: Vocational Rehabilitation (VR), Comprehensive Rehabilitation Services (CRS) and Independent Living Client Services.

Having a spinal cord injury means that you'll be using services from the healthcare system throughout your life. To access healthcare to your best advantage, you must keep two things in mind:

First, it's extremely important that you gain a thorough knowledge of your own healthcare needs, since many healthcare professionals outside of a rehabilitation hospital have limited experience and knowledge about spinal cord injury. When you see your doctor or other health professional, communicate clearly and specifically your concerns and needs. Put complete and current information about your health in writing and have it available for easy referral.

Second, you must learn everything you can about your particular healthcare plan. With a growing need to control rising healthcare costs, health insurance plans have become more restrictive than in years past. You'll need to become knowledgeable about what your health insurance does and does not cover. Become familiar with your own "certificate of coverage," which explains your benefits in detail. Just because another patient has the "same insurance" does not mean that you have identical benefits. The particular benefits and limitations that apply to an individual differ even with the same employer.

If you've been denied payment for a claim or have questions about the terminology on the Explanation of Benefits (EOB) form, contact your claims representative for additional information. Many insurance companies now allow you to access this information on the Internet. If you believe your claim is reasonable, you have a right to file a formal request for reconsideration. You also have

the right to file a complaint with your State Department of Insurance. Be sure to keep complete and timely notes about all conversations and to follow the guidelines provided to you with the denial letter. The process for reconsideration (or appeal) may vary from one payer to another.

Healthcare insurance may be available through an employer, self-employment or the government, and you may or may not have a choice of the type of plan. In addition, to get the most cost-effective health coverage, some employers may negotiate for new insurance plans frequently. As a result, these changes in healthcare providers may require that you choose from a new list of physicians covered with each new plan.

When selecting your physician, choose someone who is either familiar with spinal cord injury or is interested in learning about it. Find someone who wants to communicate with you as a consumer and sees you as an important resource in preventing complications and maintaining good health.

**SELECTING A HEALTHCARE PLAN**

The following information outlines various types of health insurance plans currently available:

**Indemnity Healthcare Plan.** Often referred to as "fee-for-service," this health plan is the one we usually think of as traditional health insurance. Indemnity plans pay healthcare professionals for services based on actual charges for those services. There is enormous variation in the range of services provided through indemnity health plans. Depending on the plan, there will be great differences in the amounts of deductibles, co-payments, yearly limits and services covered. For example, a "bare bones" plan may cover a portion of hospitalization cost, where a comprehensive plan will cover doctor visits, hospitalization, prescription drugs, durable medical equipment and other services. An indemnity plan will offer you the greatest choice of healthcare professionals, but you will be required to pay a greater portion out of pocket. With an indemnity plan, there is rarely a personal care physician (PCP) or referral requirement.

**Health Maintenance Organization (HMO).** An HMO is a healthcare program that provides healthcare services to its members at a fixed cost per member. HMOs offer preventive healthcare services for routine illness and injury, hospitalization and other services for serious illnesses. HMOs do not usually have deductibles that have to be met, but typically have co-payments for doctor visits, hospitalizations, prescription drugs, durable medical equipment and other services. With an HMO, a personal care physician (PCP) is required to direct your care, and referrals for other physicians and services are almost always required.

**Preferred Provider Organization (PPO).** A PPO is a healthcare program that provides services to its members through arrangements with healthcare professionals and hospitals that agree to negotiate rates for the services provided. PPOs typically charge an annual deductible that must be met by each member or family and may also charge co-payments for services provided. Co-payments may be dropped or significantly reduced if you use professionals and facilities that are part of the plan, but they usually rise if you choose professionals or facilities that are not part of the plan. PPOs offer greater choices of health professionals than HMOs, but it may cost you more in out-of-pocket expenses than if you selected an HMO.

**Point of Service (POS).** A point of service plan is a combination of an HMO and indemnity plan. There is usually a limit to the lifetime maximum benefit, but you may choose to use a provider who participates in the HMO and pay a lower out-of-pocket cost, or choose a provider of your own and pay a higher percentage of the cost.

**Medicare.** This insurance program is available to people 65 and older. It is also available to individuals with a disability who have been receiving Social Security Disability Insurance (SSDI) for two years. Although Medicare pays for rehabilitation services, the two-year waiting period may not be practical for those who have no other insurance. There are different parts to Medicare:

**Medicare hospital insurance (Part A)** covers hospital care and certain follow-up care after discharge.

**Medicare medical insurance (Part B)** covers doctors' services, outpatient hospital services and some medical equipment. It also covers medical items and services not covered under hospital insurance. Part B is an option, and you are responsible for paying premiums.

**Medicare prescription coverage (Part D)** pays part or in some cases almost all of its members' prescription drug costs. Part D is an option, and you'll need to decide if the Medicare plan is right for you or whether you'd like to cover your prescription drug costs in another way.

**Medicaid.** This joint federal and state program pays for healthcare for eligible people with no insurance who have low incomes and few assets. Open to persons who qualify for Supplemental Security Income (SSI) and Temporary Assistance for Needy Families (TANF), Medicaid services vary from state to state and may or may not include rehabilitation. To apply, call your state Department of Health and Human Services.

### WHAT IS MANAGED CARE?

Managed care is a system of healthcare coverage that includes a range of integrated services, facilities and products. This system of healthcare came out of the need to contain healthcare costs. HMOs (see above) and PPOs are probably the best known examples of managed care systems.

If you're considering enrolling in an HMO or PPO, you may want to ask the following questions:

- Can my primary care doctor be a physiatrist or other specialist knowledgeable about spinal cord injury and medical rehabilitation?
- Can I see a doctor out of the plan? If so, is there a fee?
- Do I have to pay extra if I want a second opinion?
- Which hospitals does the plan use?
- Does the plan provide a full range of medically necessary services for people with severe disabilities, including home health services?
- Is durable medical equipment (e.g., wheelchairs, walkers, bathroom equipment, etc.) covered? What is the dollar limit, if any, for this?
- Does the plan cover post-hospitalization home care?
- Does the plan cover prescription medications?
- Is there a co-payment per doctor visit?
- What is the deductible? What is the total out-of-pocket expense limit?
- What is the maximum lifetime coverage per person?

If your plan is deficient in one or more of these areas, you may consider purchasing an additional major medical policy with a high deductible (\$1,000 to \$2,000). These policies offer relatively low-cost protection against financial devastation by an unexpected illness or injury.

### OTHER INSURANCE TERMS

You'll hear a number of terms describing services covered by insurance. The following terms are used frequently, but their meanings may vary from plan to plan. Make sure that you and your plan representative are defining the terms the same way.

**Claim.** A demand to your health plan or insurer to pay for benefits under the insurance contract. Filing claims and completing paperwork for a claim can be complicated. Under an HMO or PPO, your paperwork will be minimized.

**Coinsurance.** A requirement that you pay a certain percentage of each claim you submit to the health plan, usually up to a specified annual deductible and out-of-pocket limit.

**Co-payment.** A fixed amount of money you're required to pay for each service you receive. For example, most health plans require that you pay a certain amount (usually \$5 to \$10) for your prescription medicines. Co-payment charges will vary from plan to plan.

**Deductible.** The amount you must pay before your health plan begins to pay for care, typically through an indemnity health plan or PPO. Deductibles usually range from \$250 to \$1,000.

**Durable Medical Equipment (DME).** Used for long-term health-related conditions, DME includes wheelchairs, orthotic devices and respiratory assistive devices. Many HMOs cover the full cost of DMEs, while PPOs usually require a co-payment. Indemnity healthcare plans may exclude DME entirely or may require a co-payment. In some plans, there's a separate benefit for DME and orthotics.

**Exclusions.** Products and services not covered by your plan. You may not find out about some exclusions until after you join a plan and want to obtain services or file a claim. Although you may request reconsideration for a denied claim for an excluded service, these types of

denials are rarely overturned.

**Grievance procedure.** Some plans may have a formal process that you can follow if you believe you are not getting proper service from the plan. Through the grievance procedure, you may request a review of service decision, payment of claims or information about the range and quality of services you have received. Ask for the procedure in writing and have your plan representative explain how you can use the procedure.

**Lifetime maximum cap.** Indemnity healthcare plans and most PPOs usually put a lifetime maximum cap on benefits they will cover. This amount can vary from \$500,000 to \$2 million. Most HMOs do not have lifetime maximum caps, making these plans more attractive to people with disabilities.

**Medically necessary services.** The services that healthcare plan officials consider necessary for you to recover from disease or avoid serious health problems. The medical management or care coordination department of your health plan determines if services are medically necessary. The decision should be based on your healthcare history and established standards for care for particular healthcare conditions. Unfortunately, if you have a disability, standards of care are often lacking. Therefore, your healthcare plan may not cover a service that you require or have had done because the plan does not consider it medically necessary.

**Out-of-plan providers.** This includes physicians and other healthcare professionals whose services are not paid for in your healthcare plan. HMOs typically do not pay for any services delivered by out-of-plan providers, except for emergency care or when the services have been approved in advance. PPOs may pay for services delivered by out-of-plan providers at a rate lower than that paid to in-plan providers. Indemnity healthcare plans will usually pay any provider up to the percentage stipulated in the benefits plan for medically necessary services at reasonable and customary rates.

**Out-of-pocket expenses.** These are costs that you have to pay with your own money for the healthcare services that you receive, including any premiums that you may have to pay for in your healthcare plan, such as deductibles and

co-payments, as well as other costs for medical supplies, prescriptions, transportation, mental health services, etc. Most PPOs and indemnity plans have an annual out-of-pocket maximum.

**Pre-existing conditions.** These are health-related conditions you have prior to entering a healthcare plan. Limitations on coverage of pre-existing conditions are usually imposed by indemnity plans and by some PPOs. Most plans that limit coverage on pre-existing conditions consider any condition related to a disability as pre-existing. The limitations on coverage of these conditions usually involve some waiting period after you have enrolled in a plan during which time the plan will not cover healthcare service related to that condition. Typical waiting periods are six or 12 months, but in some cases, plans may permanently exclude coverage for pre-existing conditions.

**Premiums.** These costs are paid by you, your employer or a government agency for your participation in a healthcare plan. If your employer passes on a portion of the premium to you, it usually appears as a deduction on your paycheck. Premiums that you pay for must be figured into out-of-pocket cost estimates when you are choosing a healthcare plan.

**Primary care physician (PCP).** Your PCP is a physician, usually either a medical doctor (M.D.) or doctor of osteopathy (D.O.), whom you see first when you need medical services. These doctors are usually in private practice in the fields of internal medicine, family medicine or pediatrics. In some cases, obstetricians and gynecologists may be considered primary care physicians. If you're enrolled in an HMO, you will need to select a PCP, usually from a list. Once you select a PCP, you will see this person before going on to any other healthcare services. Without a referral from the PCP, the plan is not likely to pay for other services you obtain. In addition, regardless of the type of healthcare plan you choose, it's imperative that you have a primary physician to treat you for medical issues not related to your spinal cord injury. Most physical medicine and rehabilitation physicians do not act as PCPs, so they do not provide routine care such as labs and physicals.

**Specialty physicians or specialists.** These are physicians or other healthcare professionals who are not considered primary care providers. Specialists include urologists, pulmonologists, rheumatologists and physical medicine and rehabilitation physicians. People with disabilities may use the services of specialists more frequently than people without disabilities. Under certain healthcare plans, such as HMOs and PPOs, you may find it harder to access the services of specialists that you would like to use. In HMOs and some PPOs, you will have to visit your primary care physician and obtain a referral from him or her before seeing a specialist.

**Usual and customary charges.** These are amounts typically charged for a particular healthcare service by professionals in the area where you live. A panel of physicians selected by healthcare plan officials usually determines these charges. Usual and customary charges (also referred to as reasonable and customary) are used by indemnity healthcare plans and PPOs for services provided by out-of-plan professionals. It's important to understand when payment for services under a particular plan is based on usual and customary charges. If it is and you choose a healthcare professional who charges more than the usual and customary amount, you'll be responsible for the difference.

Be aware of your healthcare needs and what your health insurance plan will and will not cover, so that you can assert your rights for healthcare benefits for which you are eligible. Above all, be persistent. The more you understand about the details of your health plan coverage, the better your overall healthcare will be for you.



In recent years, researchers and scientists have made tremendous gains in understanding the effects of injuries to the spinal cord and in developing research techniques that may lead to the reversing of those effects. Now even those who thought they would never see a “cure” for spinal cord injury believe that there will be dramatic breakthroughs in the future.

The challenges are to:

- **Contain the damage** that occurs within a short time after an initial injury. This damage includes hemorrhage from broken blood vessels, swelling of the spinal cord and destruction of nearby healthy cells by chemicals released from injured cells.
- **Encourage regeneration** of nerve cells by controlling substances that prevent new growth of nerve cells or by finding substances that promote re-growth.
- **Guide new cells to the proper targets** and thereby establish the proper re-connections. This may involve bridging the gap over the injured area of the spinal cord or breaking down scar tissue that impedes the proper connections.
- **Replace cells** that have died with stem cells generated from other tissue.

Some efforts and milestones you may hear about include:

- Identifying the proteins that prevent regeneration of nerve cells and discovering ways to control them.
- Introducing growth factors into the environment around the injury site to encourage the growth of new nerve cells.
- Transplanting stem cells from the umbilical cord, fetal or embryonic central nervous system.
- Manufacturing cells by genetic engineering and then grafting them to the injured spinal cord.
- Implanting Schwann cells (responsible for regeneration in the peripheral nervous system) or olfactory cells (found where nerves from the nose connect with the brain) into the central nervous system.
- Using drugs that help cells conduct impulses by re-myelinating the nerve cells. (Myelin sheaths surround nerve cells and carry the signals.)
- Using methylprednisolone (a corticosteroid) along with other drugs within eight hours of injury to reduce the inflammation caused by the injury process.

In addition to the basic science advances listed above, there are also new techniques that offer the promise of increased function to persons with spinal cord injury. These include electrical stimulation (implanting electrodes to stimulate nerves so that paralyzed muscles contract) and body weight-supported treadmill training in which patients are partially unweighted and practice automatic walking patterns on a treadmill.

Despite the impressive advances that are being made in the lab, it's important to remember that it will take more time before these scientific breakthroughs become reality for persons with spinal cord injury. Translating techniques that work in a laboratory-controlled study to human trials presents a huge challenge. Many of these breakthroughs create new obstacles or complications; for example, stem cells often trigger overgrowth, resulting in tumor formation. Federal agencies are very cautious to approve human clinical trials that may affect public safety, and it may take years for a particular drug or technique to become part of medical protocols.

Most importantly, maintaining a healthy lifestyle following spinal cord injury is crucial so that you can avoid complications and be ready to take advantage of any opportunities that scientists may present in the future.

## RESOURCES

---

*Autonomic Dysreflexia: A Patient Guide to Management*, 21-minute videotape, Sharp Rehabilitation Center, San Diego, CA, 619.541.2788.

*Autonomic Dysreflexia*, one-page fact sheet, Arkansas Spinal Cord Commission, Little Rock, AR, 501.296.1792.

*Medical Alert Card*, two-sided laminated card, TIRR Memorial Hermann, Houston, TX, 713.797.5945.

*Common Urological Problems:*

*Leakage Around the Catheter*

*Common Urological Problems:*

*Frequent Catheter Changes*

*Foley Catheter Care: Urethral or Suprapubic*

Order through the Arkansas Spinal Cord Commission, Little Rock, AR, 1.800.459.1517

*Caring for Your Urinary System*, RRTC on Community Integration for Individuals with SCI, Houston, TX, 713.797.5945

*Current Urologic Management of the Patient with SCI* videotape, Spain Rehabilitation Center, 1717 Sixth Avenue, South, Birmingham, AL, 205.934.3283

*Learning About Catheterization (Males and Females)* videotapes, 111 Colchester Avenue, Burlington, VT 05401, 802.656.5385

*SCI Info Sheet #11 – Bladder Management*, UAB Spain Rehabilitation Center, 1717 Sixth Avenue, South, Birmingham AL, 205.934.3283

*Intermittent Self-Catheterization: Males and Females*, University of Michigan Medical Center, Ann Arbor, MI, 313.763.0971

*Urinary Tract Infections*, University of Kansas RRTC in Independent Living, Lawrence, KS, 913.864.4095

*Bowel Management: A Manual of Ideas and Techniques*, Accent on Living, Bloomington, IL, 1.800.787.8444.

*Bowel Management in Spinal Cord Injury*, Arkansas Spinal Cord Commission, Little Rock, AR, 1.800.459.1517.

*Bowel Management*, Craig Hospital, Denver, CO, 303.789.8257.

*SCI Info Sheet #9 - Bowel Management*, UAB Regional Model SCI System, Birmingham, AL, 205.934.3283.

*Taking Care of Your Bowels: The Basics and Ensuring Success*, University of Washington, Seattle, WA, 206.685.3999.

### ONLINE RESOURCES

[www.abledata.com](http://www.abledata.com)

[www.abilityhub.com](http://www.abilityhub.com)

[www.tashinc.com](http://www.tashinc.com)

[www.enablemart.com](http://www.enablemart.com)

[www.rehabtool.com](http://www.rehabtool.com)

### RESOURCES FOR ALCOHOL AND DRUG ABUSE INFORMATION

– **National Clearinghouse for Alcohol and Drug Information**

1.800.729.6686

[www.health.org](http://www.health.org)

– **International Center for Disabled Chemical Dependency Services**

212.481.5780

– **Alcohol Abuse Emergency – 24 hour National Drug and Alcohol Referral Line**

Hotline: 1.800.252.6465

– **National Council on Alcoholism and Drug Dependence**

Hotline: 1.800.475.4673

[www.ncadd.org](http://www.ncadd.org)

– **National Institute for Drug Abuse**

1.800.662.4357

1.800.662.9832 (Spanish)

## RESOURCES

---

### - **Substance Abuse Resources for Disabled Individuals (SARDI)**

Wright State University  
SARDI Program  
Boonshoft School of Medicine  
Wright State University  
P.O. Box 927  
Dayton, Ohio 45410-0927

Voice/TTY: 937.775.1484  
Fax: 937.775.1495  
e-mail: SARDI Program

### - **National Association on Alcohol Drugs, and Disability, DNO**

650.578.8047  
www.naadd.org

### **HOUSTON-AREA OUTPATIENT RESOURCES FOR SUBSTANCE ABUSE COUNSELING**

**AA Intergroup** ..... 713.686.6300  
Provides information on and locations of area 12-step meetings (AA, NA, Al-Anon, etc.). Not all meeting places are accessible. Al-Anon is the 12-step group meetings for family members of an alcoholic or drug user.

**Bay Area Crisis Hotline**..... 281.461.9992

**Bay Area Council on Drugs and Alcohol** ..... 281.280.0800  
Has an outpatient treatment program for individuals. Offers a sliding-scale fee if no insurance is available.

**Baylor Psychiatric Clinic**..... 713.798.4856  
One Baylor Plaza. Has a sliding scale fee if no insurance is available.

**Crisis Hotline** ..... 713.527.9864  
**Spanish Hotline** ..... 713.526.8088  
24-hour, seven-day-a-week crisis intervention telephone service. Calls are anonymous; information and resources on various issues can be obtained.

**Family Service Center** ..... 713.861.4849  
4625 Lillian St. Offers individual and family counseling on a sliding scale fee basis. Parking is free and the building is accessible.

**Depelchin Children's Center**..... 713.861.8136  
Counseling is available for a wide range of issues including school problems and relationship issues.

**Houston Council on Alcoholism and Drug Abuse** ..... 713.942.4100  
Information, referral and educational classes regarding issues of alcohol and substance abuse.

**UT Mental Science Institute**..... 713.500.2500  
1300 Moursund. Individual and family counseling on a sliding-scale fee basis, providing that the individual has no insurance. Must call intake for an appointment. Disabled parking spaces are available in the front parking lot.

Similar organizations may be located in your area. Consult your telephone directory.

### **ADDITIONAL RESOURCES**

**Substance Abuse in Rehabilitation Facilities—No Problem? Think Again...**,  
30-minute videotape, Baylor College of Medicine, 1995.  
713.797.5945

### **Spinal Cord Injury and Alcohol: A Workbook for Making Decisions After Injury.**

Cameron, JS and Halla-Poe, D, Thompson and Company, 1987. 612.722.4235

For additional reading and viewing information on substance abuse, please check with the TIRR Memorial Hermann Librarian.

### **RESOURCES**

**These resources are used in the Sexuality RAPS class in the education series.**

*Sexuality and Spinal Cord Injury*, McDonald, Lloyd, Murphy and Russert 1993. SCI Center, Froedtert Memorial Lutheran Hospital, Milwaukee, Wisconsin 53226.

*Sexuality After Spinal Cord Injury: Answers to Your Questions*, Ducharme, Ph.D., Stanley and Gill, Ph.D., Kahtleen J., 1997, Paul H. Brookes Publishing Co. Baltimore, Maryland 21285.

## RESOURCES

---

*General Sexual Positioning Options for Persons with SCI*, Compiled by Katy Bernshausen, M.S., PT, The Institute for Rehabilitation and Research, Houston, Texas.

713.696.8060 – Houston  
512.438.4311 – Statewide

### PERSONAL CARE RESOURCES

**The Texas Department of Aging and Disability Services (DADS)** has numerous programs to assist eligible clients locate and pay for personal care assistance. Availability of services may vary from county to county. Contact your local DADS office to determine the availability of services in your area.

**Client-Managed Attendant Services (C-MAS)** provides personal care assistance to individuals with physical disabilities who are able to either direct their own care or have someone who can provide this direction. Clients interview, hire, train, supervise and release their attendants.

Eligibility: Age 19, Medicaid-eligible or sliding fee when income-based, able to direct care or identified individual responsible for direction of care.

The following description of DADS programs is taken from *“Working the Maze 2000: An Overview of Personal Assistance Services in Texas,”* a project of the Coalition of Texans with Disabilities, March 2000.

713.692.1635 – Houston

**Primary Home Care** (PHC also called Provider Care) provides essential in-home, non-technical personal assistance, i.e. bathing, dressing, feeding, grooming, toileting, transferring, escort and some homemaker activities, to individuals with disabilities.

**Personal Assistance Services (PAS)** provides personal assistance services for individuals with a disability who are employed with a net income of at least \$300/month.

Eligibility: Age 18, employed at least 20 hours a week, require personal care assistance.

Eligibility: No age limit, SSI and Medicaid eligible and meet physical eligibility criteria.

713.692.1635 - Houston

713.692.1635 – Houston Area

**Family Care** provides non-skilled, non-technical service to eligible individuals with functional limitations. Services are essentially the same as Primary Home Care.

**Community-Based Alternatives (CBA)** provides home- and community-based services to aged and disabled adults as cost-effective alternatives to nursing home care. Services may include adaptive aids, adult foster care, residential care, emergency response services, nursing services, home modifications, attendant care, therapy services, respite care and home-delivered meals.

Eligibility: Age 18 or older, Medicaid recipient or income-based.

Eligibility: Age 21, Medicaid-eligible or meet income and resource requirements for Medicaid benefits in a nursing home.

713.692.1635 – Houston Area

713.692.1635 – Houston

**In-Home and Family Support** provides direct grant benefits to purchase services that help an individual with a disability remain in the community. Services may include purchase of equipment, home modifications, therapy services, counseling, attendant care, respite care, transportation, etc.

**Community Living Assistance and Support Service (CLASS)** provides home and community-based services to people with related conditions as a cost-effective alternative to institutional placement. Related conditions refer to a condition, other than mental retardation, which began before age 22 and affects the ability to provide self-care. Services may include case management, rehabilitation, respite care, nursing services, psychological services, therapy services, adaptive aids and home modifications.

Eligibility: Minimum 4 years of age, income eligibility and meet functional guidelines.

## RESOURCES

---

Eligibility: Disability occurs prior to age 22, or financially eligible for Medicaid if residing in a Medicaid facility, functional limitations that affect independence.

Call 713.271.5795 to be added to waiting list (waiting list of many years in Houston)

**Adult Foster Care (AFC)** provides 24-hour living arrangement with supervision in an adult foster home for persons who, because of physical, mental or emotional limitations are unable to function independently in their own home.

Eligibility: Age 18, functional limitations, income-specific. 713.692.1635 – Houston

### SAFETY RESOURCES

**Fire Department Decal.** Fire Departments often have free decals or stickers for use at the home of a disabled person. The decals can be placed in the front door and on the window of the disabled person's room to alert a fireman that a disabled person lives there. Call your local fire department for information.

**Personal Response Systems.** Several personal systems are available (National Lifeline toll free 1.800.543.3546) to assist disabled or socially isolated persons in living more independently with confidence. The Department of Aging and Disability Services may also offer a personal response system for income-eligible persons. When choosing a personal response system, consider the cost, services provided and the reputation of the system in the community.

**Special Telephone Information.** Information on special telephone equipment and services for persons with hearing, sight, speech or mobility impairment is available through your local through your local phone service provider business office. If the special phone equipment is going to be needed indefinitely, it may be less expensive to purchase it from a private telephone sales store. If you purchase the equipment, you avoid a monthly rental charge. Your occupational therapist may be able to answer questions about the type of special phone that could best meet your needs.

**Handicapped User Exemption from Directory Assistance Charges.** You may be exempt from payment for Directory Assistance if you have a physical or visual disability preventing you from using the phone book. You must complete a form to qualify for this exemption. For information, contact your phone service provider.

### ORGANIZATIONS AND INFORMATION CENTERS

#### – Spinal Cord Injury Information Network

619 19<sup>th</sup> Street South, SRC-529  
Birmingham, AL 35249  
205.934.3283  
[www.spinalcord.uab.edu](http://www.spinalcord.uab.edu)

#### – National Spinal Cord Injury Association (NSCIA)

6701 Democracy Boulevard, Suite 300-9  
Bethesda, MD 20817  
1.800.962.9629  
[www.spinalcord.org](http://www.spinalcord.org)

#### – Paralyzed Veterans of America

801 18th Street, NW  
Washington, DC 20006  
1.800.424.8200  
[www.pva.org](http://www.pva.org)

#### – TIRR Memorial Hermann Library

1333 Moursund Street  
Houston, TX 77030  
713.797.5947

#### – TIRR Memorial Hermann

1333 Moursund Street  
Houston, TX 77030  
[www.tirr.org](http://www.tirr.org)

#### – Mission Connect

[www.missionconnect.org](http://www.missionconnect.org)

#### – National Database of Education Resources on Spinal Cord injury

[www.msdisseminationcenter.org](http://www.msdisseminationcenter.org)



## RESOURCES

---

### - **Center for Research on Women with Disabilities**

Baylor College of Medicine, Dept. PM&R  
6550 Fannin, Suite 421  
Houston, TX 77038  
1.800.44.CROWD (27693) or 713.798.5782  
[www.bcm.tmc.edu/crowd](http://www.bcm.tmc.edu/crowd)

### - **American Spinal Injury Association (ASIA)**

2020 Peachtree Road, NW  
Atlanta, GA 30309-1402  
404.355.9772  
[www.asia-spinalinjury.org](http://www.asia-spinalinjury.org)

### - **Christopher Reeve Paralysis Foundation**

500 Morris Avenue  
Springfield, NJ 07081  
1.800.225-0292 or 973.379.2690  
[www.christopherreeve.org](http://www.christopherreeve.org)

### - **Miami Project to Cure Paralysis**

P.O. Box 016960 (R-48)  
Miami, FL 33101  
1.800.782-6387 or 305.243.6001  
[www.miamiproject.org](http://www.miamiproject.org)

### - **Wheelchair Internet Site**

[www.wheelchairnet.org](http://www.wheelchairnet.org)

### - **Spinal Cord Injury Rehab Resources**

[www.makoa.org/sci.htm](http://www.makoa.org/sci.htm)

### - **National Sports Center for Disabled**

[www.nscd.org](http://www.nscd.org)

### - **SpinLife**

[www.spinlife.com](http://www.spinlife.com)

### - **Kent Waldrep National Paralysis Foundation**

14651 Dallas Parkway, Suite 136  
Dallas, TX 75240  
1.800.925.CURE

### - **Spinal Cord Society**

19051 County Highway 1  
Fergus Falls, MN 56537  
218.739.5252

## LOCAL RESOURCES

### - **Houston Center for Independent Living (HCIL)**

7000 Regency Square Boulevard, Suite 160  
Houston, TX 77036  
713.974.4621  
[www.coalitionforbarrierfreeliving.com](http://www.coalitionforbarrierfreeliving.com)

### - **Advocacy, Inc.**

1500 McGowen St., Suite 100  
Houston, TX 77004  
713.974.7691  
1.800.880.0821  
[www.advocacyinc.org](http://www.advocacyinc.org)

### - **United Way of Texas, Gulf Coast Chapter**

2200 North Loop West  
Houston, TX 77018  
713.685.2300  
713.957.4357 Helpline  
[www.uwtgc.org](http://www.uwtgc.org)

## PUBLICATIONS

### - **New Mobility**

Subscription rate: \$27.95 for 12 issues  
1.888.850.0344  
[www.newmobility.com](http://www.newmobility.com)

### - **Sports 'N Spokes**

Subscription rate: \$21.00 for six issues  
1.888.888.2201  
[www.sportspokes.com](http://www.sportspokes.com)

### - **Paraplegia News**

Subscription rate: \$23.00 for 12 issues  
1.888.888.2201  
[www.pvomagazines.com/pnnews](http://www.pvomagazines.com/pnnews)  
Published by the PVA, covers research, legislation, travel, etc.

## RECREATION AND LEISURE RESOURCES ORGANIZATIONS

### - **Wheelchair Sports, USA**

1668 320th Way  
Earlham, IA 50072  
Phone/Fax 515.833.2450  
email: [wsusa@aol.com](mailto:wsusa@aol.com)  
[www.wsusa.org](http://www.wsusa.org)

## RESOURCES

---

### - **The National Center on Physical Activity and Disability (NCPAD)**

1640 West Roosevelt Road  
Chicago, IL 60608-6904  
1.800.900.8086  
email: ncpad@ulc.edu  
www.ncpad.org

### - **All-Terrain and Motorcycling:**

Wheelchair Motorcycle Association, Inc.  
101 Torrey Street  
Brockton, MA 02401  
508.583.8614  
Contact Person: Dr. Eli Factor

## ART

### - **Mouth and Foot Painting Artists**

2070 Peachtree Court, Suite 101  
Atlanta, GA 30341  
770.986.7764  
email: mfpausa@bellsouth.net  
www.mfpausa.com

## BASKETBALL

### - **National Wheelchair Basketball Association**

6165 Lehman Drive Suite 101  
Colorado Springs, Colorado 80918  
719.266.4082  
email: toddhatfield@nwba.org  
www.nwba.org

## BOWLING

### - **American Wheelchair Bowling Association**

P.O. Box 69  
Clover, Virginia 24534-0069  
434.454.2269  
email: bowlawba@aol.com  
www.awba.org

## CANOEING

### - **American Canoe Association Kayaking/Disabled Paddlers Committee**

7432 Alban Station Blvd., Suite B-232  
Springfield, VA 22150  
703.451.0141  
email: aca@americancanoe.org  
www.acanet.org

## - **HANDCYCLING**

### **United States Handcycle Federation**

P.O. Box 3538  
Evergreen, CO 80437  
303.679.2770  
email: info@ushf.org  
www.ushf.org

## FLYING

### - **Freedom's Wing International, Inc.**

P.O. Box 7076  
East Brunswick, NJ. 08816  
1.800.382.1197  
e-mail: murph771@freedomswings.org  
www.freedomswings.org

### - **International Wheelchair Aviators**

P.O. Box 2799  
Big Bear City, CA 92314  
909.585.9663  
email: IWAviators@aol.com  
www.wheelchairaviators.org

## GARDENING

### - **American Horticultural Therapy Association**

3570 East 12<sup>th</sup> Ave. Suite 206  
Denver, CO 80206  
1.800.634.1603  
email: joy@ahta.org  
(Administrative Director: Joy Harrison)  
www.ahta.org

## HORSEBACK RIDING

### - **North American Riding for the Handicapped Association**

P. O. Box 33150  
Denver, CO 80233  
1.800.369.7433  
email: NARHA@NARHA.ORG  
www.narha.org

## OUTDOOR RECREATION

### - **Turning P.O.I.N.T.**

403 Pacific Ave.  
Terrell, TX 75160  
979.524.4231  
email: point@turningpointtexas.org  
www.turningpointtexas.org

## RESOURCES

---

### QUAD RUGBY

- **U.S. Quad Rugby Association**  
5861 White Cypress Drive  
Lake Worth, FL 33467-6230  
561.964.1712  
www.quadrugby.com

### ROWING

- **U.S. Rowing Association**  
www.usrowing.org

### SAILING

- **National Ocean Access Project**  
P. O. Box 1705  
Rockville, MD 20849-0726  
301.271.9843
- **Shake-a-leg**  
P.O. Box 1264  
Newport, RI 02840  
401.849.8898  
email: shakealeg@shakealeg.org  
www.shakealeg.org

### SCUBA DIVING

- **Handicapped Scuba Association**  
1104 El Prado  
San Clemente, CA 92672-4637  
949.498.4540  
email: hsa@hsascuba.com  
www.hsascuba.com

### SKEET SHOOTING

- **National Skeet Shooting Association**  
5931 Roft Road  
San Antonio, TX 78253  
1.800.877.5338  
email: nssa@nssa-nsca.com  
www.nssa-nsca.com

### SNOW SKIING

- **Adaptive Ski & Sport Programs**  
www.sitski.com
- **Ability Plus, Inc.**  
P.O. Box 253  
Waterville Valley, NH 03215  
www.abilityplus.org

### SOFTBALL

- **National Wheelchair Softball Association**  
6000 West Floyd Ave #110  
Denver, CO 80227  
303.936.5587  
www.wheelchairsoftball.com

### TENNIS

- **United States Tennis Association**  
1.800.900.8782  
email: james@usta.com (Dan James)  
www.usta.com

### TRAP SHOOTING

- **Amateur Trapshooting Association**  
937.989.4638  
email: ccollier@shootata.com  
(Connie Collier - Executive Secretary)  
www1.shootata.com

### TRAVEL AGENCIES

- **Accessible Journeys**  
35 West Sellers Ave.  
Ridley Park, PA 19078  
1.800.846.4537  
email: sales@accessiblejourneys.com  
www.disabilitytravel.com
- **Mobility International**  
P.O. Box 10767  
Eugene, OR 97440  
541.343.1284  
www.miusa.org
- **SATH (Society for Accessible Travel & Hospitality)**  
347 Fifth Ave, Suite 610  
New York, NY 10016  
212.447.7284  
email: sathtravel@aol.com  
www.sath.org

### MAGAZINES

- **Access to Travel**  
P.O. Box 43  
29 Bartlett Lane  
Delmar, NY 12054-1105  
512.439.4146

## RESOURCES

---

### - **New Horizons: Information for the**

#### **Air Traveler with a Disability**

Office of Aviation Enforcement and Processing  
400 Seventh Street, SW, #4107  
Washington, DC 20590  
<http://airconsumer.ost.dot.gov/publications/horizons.htm>

### - **New Mobility**

Circulation/Customer Service: Kim Montgomery  
215.675.9133, ext. 109  
[www.newmobility.com](http://www.newmobility.com)

### - **Open World**

347 5th Ave., Suite 610  
New York, NY 10016  
212.447.1928  
[www.sath.org](http://www.sath.org)

### - **Outdoors Forever**

P.O. Box 4832  
East Lansing, MI 48823  
517.337.0018

### - **Palaestra**

Challenge Publications, Ltd.  
PO Box 508  
Macomb, IL 61455  
309.833.1902 (Phone/FAX)/Editorial  
email: [challpub@macomb.com](mailto:challpub@macomb.com)  
[www.palaestra.com](http://www.palaestra.com)

### - **Spinal Network Extra (Now known as New Mobility)**

### - **Sports 'N Spokes**

PVA Publications  
2111 East Highland Avenue, Suite 180  
Phoenix, AZ 85016-4702  
1.888.888.2201  
[www.pvamagazines.com/sns](http://www.pvamagazines.com/sns)

## BOOKS

### - *Access America: An Atlas and Guide to the National Parks for Visitors with Disabilities*

Published in 2000  
Northern Cartographic  
P. O. Box 133, Burlington, VT 05402  
ISBN: 0944187005

### - *Accessible Gardening for People with Physical Disabilities*

Janeen R. Adil  
Published in 1994  
Woodbine House  
6510 Bells Mill Road, Bethesda, MD 20817  
ISBN: 0933149565  
1.800.843.7323

### - *Aquatics for Special Populations/YMCA*

YMCA Program Store  
Box 5077, Champaign, IL 61820  
217.351.5077

### - *Bold Tracks: Skiing for the Disabled*

Cordillera Press, Inc.  
P. O. Box 3699, Evergreen, CO 80439  
303.670.3010

### - *Canoeing & Kayaking for Persons with Physical Disabilities*

American Canoe Association  
P. O. Box 1190, Newington, VA 222-122-1190  
703.550.7495

### - *Easy Access to National Parks*

Wendy Roth & Michael Tompane  
Sierra Club Books

### - *Foder's Great American Vacations for Travelers with Disabilities, 2<sup>nd</sup> Ed.*

800.533.6478

### - *International Directory of Recreation-Oriented Assistive Device Sources*

Lifeboat Press  
P. O. Box Press, Marina Del Rey, CA 90295

## RESOURCES

---

- *Interpretation for Disabled Visitors in the National Park System*  
Special Programs and Populations Branch  
U.S. Department of the Interior  
P. O. Box 371127, Washington, DC 20013-7127  
202.343.3674
  
- *Playing and Coaching Wheelchair Basketball*  
University of Illinois Press  
54 E. Gregory Drive, Champaign, IL 61820  
1.800.638.3030
  
- *Resource Directory for Disabled Athletes*  
American Orthopedic Society for Sports Medicine  
6500 N. River Road, Rosemont, IL 60018  
847.292.4900
  
- *Scuba Diving with Disabilities*  
Leisure Press  
Box 5076, Champaign, IL 61820
  
  
- *Sports and Recreation for the Disabled: A Resource Manual*  
Benchmark Press, Inc.  
8435 Keystone Crossing, Suite 175  
Indianapolis, IN 46420
  
  
- *Tennis in a Wheelchair*  
National Foundation of Wheelchair Tennis  
940 Calle Amanecer, Suite B  
San Clemente, CA 92673  
714.361.3663
  
  
- *Wheelchair Basketball*  
PVA Sports  
801 18<sup>th</sup> Street, NW, Washington, DC 20006  
1.800.424.8200
  
  
- *The Wheelchair Traveler*  
Ball Hill Road  
Milford, NJ 03055

## YOUR RIGHTS RESOURCES

- **Southwest Disability and Business Technical Assistance Center for Region VI**  
(Arkansas, Louisiana, New Mexico, Oklahoma, Texas)  
2323 S. Shepherd, Suite 1000, Houston, TX 77019  
713.520.0232  
713.520.5136 TDD  
ADA Hotline 1.800.949.4232
  
- **Advocacy, Incorporated**  
7800 Shoal Creek Boulevard, #171-E, Austin, TX 78757  
512.454.4816  
1.800.252.9108 Main Office  
[www.advocacyinc.org](http://www.advocacyinc.org)
  
- **Coalition of Texas with Disabilities**  
316 West 12<sup>th</sup> Street #405, Austin, TX 78701-1840  
512.478.3366  
1.800.998.3363  
[www.cotwd.org](http://www.cotwd.org)
  
- **Texas Association of Centers for Independent Living (TACIL)**  
8625 King George, Suite 210, Dallas, TX 75235-2286  
214.630.4796

## ORGANIZATIONS AND INFORMATION

### CENTERS FOR ADOLESCENTS

- **National Family Caregivers Association**  
1.800. 896.3650  
[www.nfcacares.org](http://www.nfcacares.org)
  
- **Through the Looking Glass**  
1.800.644.2666 or 510.848.1112  
[www.lookingglass.org](http://www.lookingglass.org)

Research and Training Center offers support services to families in which parent or child has a disability

- **Advocacy, Inc.**  
7800 Shoal Creek Boulevard, Suite 171-E  
Austin, TX 78757-1024  
1.800.252.9108  
[www.advocacyinc.org](http://www.advocacyinc.org)

Information or assistance concerning the legal rights of persons with disabilities



## RESOURCES

---

### - **National Information Center for Children and Youth with Disabilities**

P. O. Box 1492, Washington, DC 20013-1492  
1.800.695.0285  
www.nichey.org

### - **National Parent-to-Parent Support and Information System**

P. O. Box 907, Blue Ridge, GA 30513  
1.800.651.1151  
www.nppsis.org

### - **Texas Education Agency Parent Special Education Hotline**

1.800.252.9668

### - **PATH**

1090 Longfellow, Suite B, Beaumont, TX 77706-4819  
1.800.866.4726  
www.salsa.net/~path

Information and referral; parent training, especially in educational rights; newsletter for parents

### - **Spinal Cord Injury Caregivers Discussion List**

www.delanet.com/~mp317912/scis/index1.html

### - **National Spinal Cord Injury Association**

www.spinalcord.org  
Link to Children's Services

### - **Website for Kids, Teens and Their Parents**

www.faculty.fairfield.edu/fleitais/contents.html

### - **Family Village**

www.familyvillage.wisc.edu

## PUBLICATIONS

### - **Exceptional Parent Magazine**

Customer Service  
P. O. Box 3000, Dept. EP, Danville, NJ 07834  
877.272.7368  
www.familyeducation.com

Monthly publication for parents of children with disabilities

## YOUR RIGHTS

The Individuals with Disabilities Education Act is the primary legislation providing for a free and appropriate education for children with a disability.

### - **Advocacy, Inc.**

7800 Shoal Creek, Blvd, #171-E, Austin, TX 78757  
512.454.4816  
1.800.252.9108  
www.advocacyinc.org

### - **Texas Advocates Supporting Kids with Disabilities (TASK)**

P. O. Box 162685, Austin, TX 78716  
512.336.0897  
www.texaskids.org

### - **Texas Council for Developmental Disabilities**

4900 N. Lamar Boulevard, Austin, TX 78751  
512.424.4080  
www.rehab.state.tx.us/tpcdd/index.html

## RECREATION AND LEISURE

### - **TIRR Memorial Hermann Sports**

713.528.0123

Coordinates a variety of sports activities (swimming, kayaking, basketball, etc.) and distributes a calendar of these events to people with disabilities.

### - **Children's Association for Maximum Potential (CAMP)**

(Camp located near Comfort, Texas)  
P. O. Box 27086, San Antonio, TX 78227  
210.292.3566

Provides a broad range of recreational, rehabilitative and respite services for children with disabilities and their families.

### - **Camp for All**

(Camp located near Brenham, Texas)  
Houston office: 713.686.5666

Provides recreation, sports activities and retreats for children with disabilities and their families.

## RESOURCES

---

### - West Gray Multi-Purpose Center

713.284.1973

Provides recreational swimming, as well as seasonal swimming lessons, to children with disabilities.

### - Special Olympics

10101 Fondren, Suite 350, Houston, TX 77096  
713.270.7992

Provides sports activities for people with disabilities.

### ADDITIONAL FINANCIAL RESOURCES

Individuals with disabilities and their families face many concerns relating to loss of income and increased expenses after a spinal cord injury. Federal and state programs can help a family with their money problems. Benefits and guidelines to qualify for these programs will vary from state to state.

The following is a list of some of these programs:

**Social Security Disability Insurance (SSDI)** is for individuals with disabilities. The disability must keep the person from working, and the disability is expected to last for at least 12 months. SSDI is based on credits for work the person has done under Social Security. If you qualify, SSDI will begin about six months after the disability occurred. To apply, contact the Social Security office in your area or call toll free 1.800.772.1213.

Low-income individuals may qualify for premium exemptions with the **Qualified Medicare Beneficiary** program (QMB or SLMB). Contact your local Texas Department of Aging and Disability Services (DADS).

**Supplemental Security Income (SSI)** is for persons with disabilities, regardless of age, or persons who are 65 or older. Parents of children with disabilities may apply on behalf of their children. It is not necessary for the person to have worked under Social Security to qualify for SSI. The qualification requirements for children are based on family income. For adults, the person's own income is used to determine eligibility. To apply, contact the Social Security office in your area or call (nation-wide) at 1.800.772.1213.

**Plan to Achieve Self Support (PASS)** provides for an individual receiving SSI to set aside income used for educational or vocational needs. The Social Security Administration must approve such a plan. For more information, call the Social Security Administration at 800.772.1213.

**Temporary Aid to Needy Families (TANF)** is a program for families with children who have no support from their parents. This lack of support can be because of death, absence or disability of one or both parents. The rules and the amount of the monthly payments vary from state to state. There is a two-year limit on this benefit. To apply, call your state Department of Health and Human Services.

**Food Stamp Certification** is a program to help low-income individuals and families buy food. These stamps can be spent to purchase food in grocery stores approved by the U.S. Department of Agriculture. You can apply at your state Department of Health and Human Services.

**City and County Social Services departments** are located in many communities and offer emergency or financial help to persons/families with low incomes. Services may include emergency help with rent payment or utility bills.

**Veterans Administration (VA)** benefits may be available to those who have served in the armed forces. Benefits may include non-service-related disability payments available to wartime veterans who become permanently and totally disabled. The VA may pay an additional amount for use of an attendant in certain cases. Medical assistance in a VA medical facility is open to any veteran who qualifies. You can get more information about these benefits at your nearest Veterans Affairs office.

**State Departments of Health and Human Services** have programs that aid the aged and disabled. These programs pay for attendant and homemaker care, respite care, therapy, special equipment, supplies, changes to the home and transportation for medical treatment. For more information, call your state Department of Health and Human Services.

## RESOURCES

---

**Division of Vocational Rehabilitation (DVR)** is a federal program available in each state under the Rehabilitation Services Administration. The goal of these agencies is to return disabled persons to work. Services provided may include job evaluations, job counseling and sponsorship for college tuition, books, job training and placement. Services may also include rehabilitation, medical treatment and special equipment needed to reach the job goal. DVR offices are located throughout each state. Many states have similar programs but under different auspices.

Texas has three distinct programs under **DARS (Department of Assistive and Rehabilitative Services):**

- *Vocational Rehabilitation (VR)* is designed to prepare a disabled individual for competitive employment.
- *Comprehensive Rehabilitation Services (CRS)* provides rehabilitation services to individuals with spinal cord injury or traumatic brain injury to assist in community living reintegration.
- *Independent Living Client Services (ILS)* provides non-vocational services to severely disabled clients in their homes.

- **Pharmaceutical Payment Assistance Program**  
Pharmaceutical companies often have income-based programs to reduce the cost of medications. Contact your social worker or pharmacist to determine whether any of your medications may be provided through one of these programs.

### ADOLESCENT RESOURCES

- **The Mental Health and Mental Retardation Authority of Harris County (MHMRA)**  
713.970.7070  
[www.mhmraofharriscounty.org](http://www.mhmraofharriscounty.org)

- **Texas WIC**  
1.800.942.3678  
[www.tdh.state.tx.us/wichd/gi/gi1.html](http://www.tdh.state.tx.us/wichd/gi/gi1.html)
  - Nutrition education
  - Supplemental foods

Access to public healthcare system, e.g., immunizations, family planning and prenatal care

- **Supplemental Security Income (SSI)**  
1.800.772.1213  
[www.ssa.gov](http://www.ssa.gov)
- **Children with Special Healthcare Needs (CSHCN) Services**  
713.767.3110  
[www.tdh.state.tx.us/cshcn/cidc.html](http://www.tdh.state.tx.us/cshcn/cidc.html)
- **Children's Health Insurance Program (CHIP)**  
1.800.647.6558  
[www.main.org/txchip](http://www.main.org/txchip)

Provides comprehensive health insurance to children currently uninsured.

- **Medicaid**  
1.800.252.8263
- **Medicaid Waiver Programs**  
[www.tdh.state.tx.us](http://www.tdh.state.tx.us)
- **Medically Dependent Children Program (MDCP)**  
1.800.252.8023  
[www.tdh.state.tx.us/mdcp/](http://www.tdh.state.tx.us/mdcp/)
- **Community Living Assistance and Support Services (CLASS) Program**  
1.877.438.5658
- **Home-Based and Community-Based Services**  
713.692.1635
- **Texas Health Steps (THSteps) Program**  
1.877.THSTEPS  
[www.tdh.state.tx.us/thsteps](http://www.tdh.state.tx.us/thsteps)
- **THSteps Case Management**  
1.877.THSTEPS  
[www.tdh.state.tx.us/thsteps/thstepscaseman.html](http://www.tdh.state.tx.us/thsteps/thstepscaseman.html)
- **Texas Health Steps Comprehensive Care Program (CCP)**  
512.458.7111 or toll free 1.888.963.7111  
[www.dshs.state.tx.us/thsteps/services\\_ccp.shtm](http://www.dshs.state.tx.us/thsteps/services_ccp.shtm)
- **Medicaid Transportation Program (MTP)**  
1.877.MED.TRIP  
[www.tdh.state.tx.us/mtp/index.html](http://www.tdh.state.tx.us/mtp/index.html)

## RESOURCES

---

– **Community Care for the Aged and Disabled (CCAD)**

713.803.1802

[www.dhs.state.tx.us](http://www.dhs.state.tx.us)

CCAD includes a variety of services provided to help clients stay in their own homes/communities. Primary Home Care, Day Activity and Health Services, and In-Home Family and Support Services serve medically needy children.

– **Intermediate Care Facility for Persons with Mental Retardation (ICF-MR)**

713.970.3977

[www.mhmraofharriscounty.org/MRLA/](http://www.mhmraofharriscounty.org/MRLA/)

**TIRR**  
MEMORIAL<sup>®</sup>  
HERMANN  
Rehabilitation & Research